

# SEL V400+ HYBRID RESIN



Designated according to The Construction Products (Amendment etc.) (EU Exit) Regulations 2020

UK Technical Assessment	UKTA-0836-22/6236 of 29/07/2022
Technical Assessment Body issuing the UK Technical Assessment:	British Board of Agrément
Trade name of the construction product:	SEL-V400+
Product family to which the construction product belongs:	Area Code 33, Bonded fasteners for use in concrete
Manufacturer:	Selkent Fastenings Ltd.
Manufacturing plant(s):	Manufacturing Plant No. 1
This UK Technical Assessment contains:	46 pages including 3 annexes which form an integral part of this assessment
This UK Technical Assessment is issued in accordance with The Construction Products (Amendment etc.) (EU Exit) Regulations 2020 on the basis of:	UKAD 330499-01-0601 <i>Bonded fasteners for use in concrete</i>

Communication of this UK Technical Assessment, including transmission by electronic means, shall be in full. However, partial reproduction may be made with the written consent of the British Board of Agrément. Any partial reproduction must be identified as such.

## 1 Technical description of the product

SEL-V400+ are bonded anchors (injection type) consisting of an injection mortar cartridge using an applicator gun equipped with a special mixing nozzle and steel element.

The steel element consists of:

- threaded anchor rod sizes M8 to M30 made of:
  - galvanized carbon steel
  - carbon steel with zinc flake coating
  - stainless steel
  - high corrosion resistant stainless steel
  - ultra-high strength steel with zinc flake coating
- anchor rod with inner thread sizes M6/Ø10 to M16/Ø24 manufactured from:
  - galvanized carbon steel
  - stainless steel
  - high corrosion resistant stainless steel
- rebar sizes Ø8 to Ø32.

The steel element is placed into a drilled hole previously injected (using an applicator gun) with a mortar with a slow and slight twisting motion. The rod or rebar is anchored by the bond between the steel element, mortar and concrete.

The threaded rods are available for all diameters with three types of tip end: a one side 45° chamfer, a two sides 45° chamfer or a flat. The threaded rods are either delivered with the mortar cartridges or commercial standard threaded rods are purchased separately. The mortar cartridges are available in different sizes and types.

The full description of the products is given in Annex A.

## 2 Specification of the intended use(s) in accordance with the applicable UK Assessment Document (hereinafter UKAD)

The performances given in Section 3 are only valid if the anchors are used in compliance with the specifications and conditions given in Annex B.

The performances given in this UK Technical Assessment are based on an assumed working life of the anchor of 50 and/or 100 years. The indications given on the working life cannot be interpreted as a guarantee given by the producer but are to be regarded only as a means for choosing the right products in relation to the expected economically reasonable working life of the works.

## 3 Performance of the product and references to the methods used for its assessment

### 3.1 Mechanical resistance and stability (BWR 1)

---

Characteristic resistance to tension load and shear load (static and quasi static loading), displacements	See Annex C1 to C15
Characteristic resistance for seismic performance category C1, displacements	See Annex C16 to C18

---

### 3.2 Safety in case of fire (BWR 2)

Not relevant.

### 3.3 Health, hygiene and the environment (BWR 3)

Not relevant.

### 3.4 Safety and accessibility in use (BWR 4)

Not relevant.

### 3.5 Protection against noise (BWR 5)

Not relevant

### 3.6 Energy economy and heat retention (BWR 6)

Not relevant.

### 3.7 Sustainable use of natural resources (BWR 7)

Performance not assessed.

### 3.8 Methods used for assessment

The assessment of the products has been made in accordance with the UKAD 330499-01-0601.

## 4 Assessment and verification of constancy of performance (hereinafter AVCP) system applied

### 4.1 System of assessment and verification of constancy of performance

According to UKAD No. 330499-01-0601 and Annex V of the Construction Products Regulation (Regulation (EU) 305/2011) as brought into UK law and amended, the system of assessment and verification of constancy of performance (AVCP) 1 applies.

## 5 Technical details necessary for the implementation of the AVCP system, as provided for in the applicable UKAD

Technical details necessary for the implementation of the AVCP system are laid down in the control plan deposited with the British Board of Agrément and made available to the UK Approved Bodies involved in the conformity attestation process.

### 5.1 UKCA marking for the product/ system must contain the following information:

- Identification number of the Approved Body
- Name/address of the manufacturer of the product/ system
- Marking with intention of clarification of intended use
- Date of marking
- Number of certificate of constancy of performance
- UKTA number.

# SEL V400+ HYBRID RESIN

Technical Assessment UKTA-0836-22/6236

Issued on 29/07/2022

On behalf of the British Board of Agrément



Date of Issue: 29 July 2022

**Hardy Giesler**  
Chief Executive Officer



**British Board of Agrément**  
1<sup>st</sup> Floor Building 3  
Hatters Lane  
Croxley Park  
Watford  
WD18 8YG

## ANNEX A : Product description

These annexes apply to the product described in the main body of the UK Technical Assessment.

Figure A1 : Threaded anchor rods

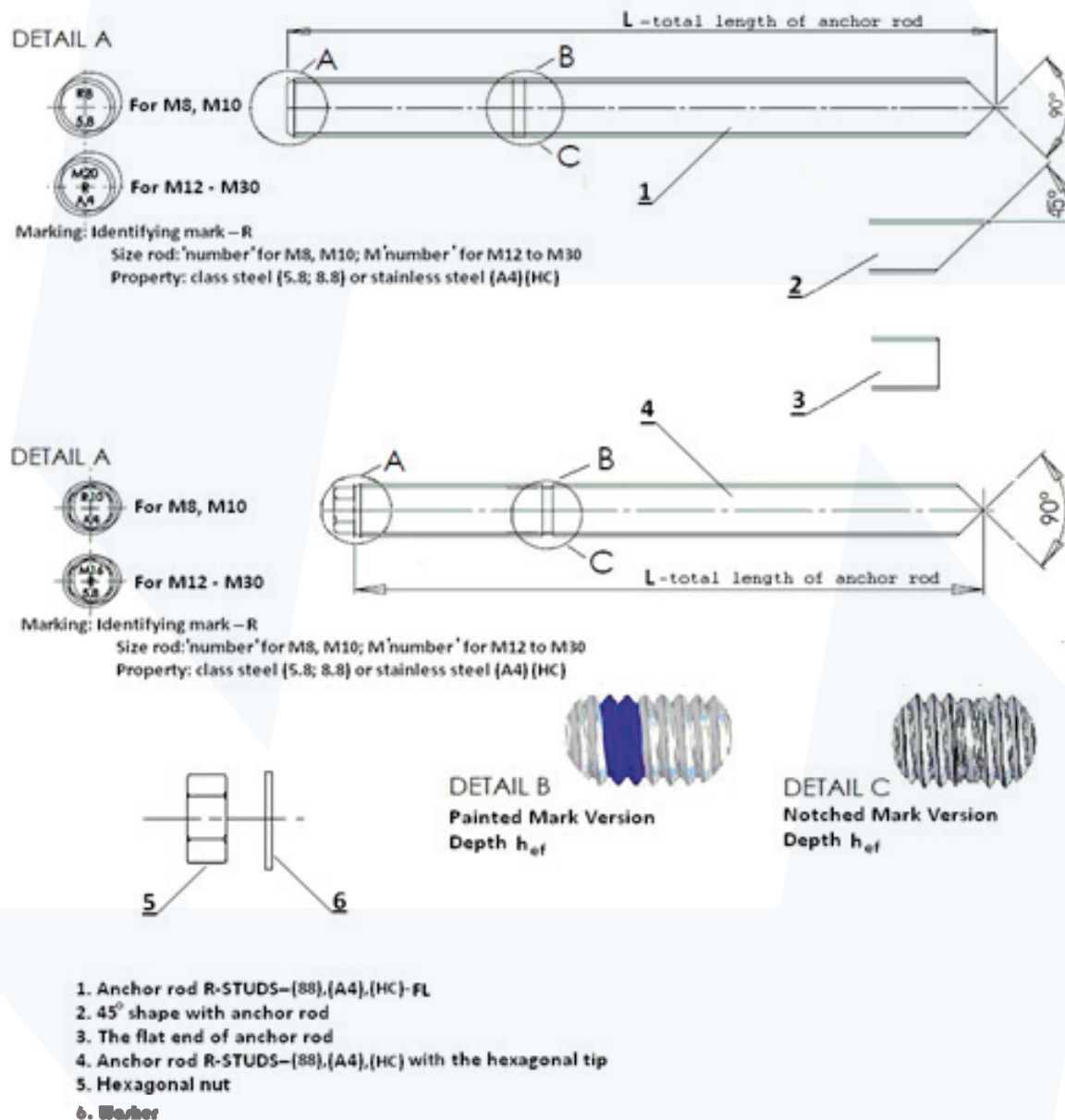

SEL-V400+

Product description  
Threaded anchor rods

Annex A1

## ANNEX A : Product description

Figure A2 : Anchor rods with inner thread

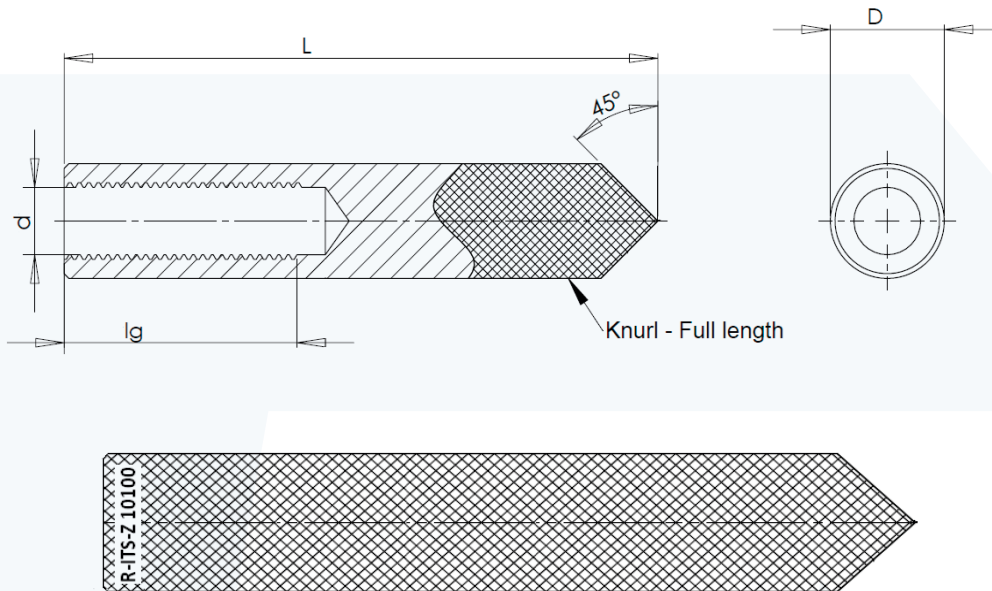

Marking: R - Identifying mark  
 ITS - product index  
 Z - carbon steel or A4 - stainless steel  
 XX - thread size  
 YYY - length of sleeve

Figure A3 : Rebar

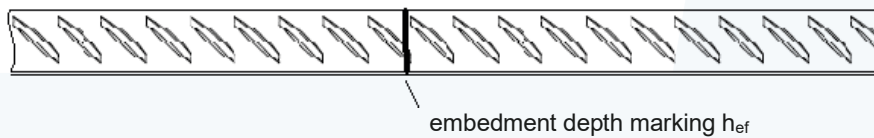

SEL-V400+	
Product description Anchor rods with inner thread and rebar	Annex A2

## ANNEX A : Product description

**Table A1: Threaded rods**

Part	Designation			
	Steel, zinc plated	Stainless steel	High corrosion resistance stainless steel (HCR)	Ultra-high Strength Steel, coated
Threaded rod	Steel, property class 5.8 to 12.9 acc. to EN ISO 898-1 electroplated $\geq 5 \mu\text{m}$ acc. to EN ISO 4042 or hot-dip galvanized $\geq 45 \mu\text{m}$ acc. to EN ISO 10684 or non-electrolytically applied zinc flake coating $\geq 8 \mu\text{m}$ acc. EN ISO 10683	Steel 1.4401, 1.4404, 1.4571 acc. to EN 10088; property class 70 and 80 (A4-70 and A4-80) acc. to EN ISO 3506 Corrosion resistance class CRC III acc. to EN 1993-1-4:2006 +A1:2015	Steel 1.4529, 1.4565, 1.4547 acc. to EN 10088; property class 70 acc. to EN ISO 3506 Corrosion resistance class CRC V acc. to EN 1993-1-4:2006 +A1:2015	Steel, property class 14.8U to 16.8U acc. to USCAR-UHSFG-1416U non-electrolytically zinc flake coating $\geq 8 \mu\text{m}$ acc. EN ISO 10683
Hexagon nut	Steel, property class 5 to 12, acc. to EN ISO 898-2; electroplated $\geq 5 \mu\text{m}$ acc. to EN ISO 4042 or hot-dip galvanized $\geq 45 \mu\text{m}$ acc. to EN ISO 10684 or non-electrolytically applied zinc flake coating $\geq 8 \mu\text{m}$ acc. EN ISO 10683	Steel 1.4401, 1.4404, 1.4571 acc. to EN 10088; property class 70 and 80 (A4-70 and A4-80) acc. to EN ISO 3506 Corrosion resistance class CRC III acc. to EN 1993-1-4:2006 +A1:2015	Steel 1.4529, 1.4565, 1.4547 acc. to EN 10088; property class 70 acc. to EN ISO 3506 Corrosion resistance class CRC V acc. to EN 1993-1-4:2006 +A1:2015	Steel, property class 12 to 16 acc. to USCAR-UHSFG-1416U non-electrolytically applied zinc flake coating $\geq 8 \mu\text{m}$ acc. EN ISO 10683
Washer	Steel acc. to EN ISO 7089; electroplated $\geq 5 \mu\text{m}$ acc. to EN ISO 4042 or hot-dip galvanized $\geq 45 \mu\text{m}$ acc. to EN ISO 10684 or non-electrolytically applied zinc flake coating $\geq 8 \mu\text{m}$ acc. EN ISO 10683	Steel 1.4401, 1.4404, 1.4571 acc. to EN 10088 Corrosion resistance class CRC III acc. to EN 1993-1-4:2006 +A1:2015	Steel 1.4529, 1.4565, 1.4547 acc. to EN 10088 Corrosion resistance class CRC V acc. to EN 1993-1-4:2006 +A1:2015	Steel acc. to EN ISO 7089; non-electrolytically applied zinc flake coating $\geq 8 \mu\text{m}$ acc. EN ISO 10683

Commercial threaded rods (in the case of rods manufactured from galvanized steel – standard rods with property class  $\leq 8.8$  only), with:

- material and mechanical properties according to Table A1,
- confirmation of material and mechanical properties by inspection certificate 3.1 according to EN10204:2004; the documents shall be stored,

SEL-V400+	Annex A3
Product description Materials	

## ANNEX A : Product description

**Table A2: Rods with inner threaded**

Part	Material		
	Steel, zinc plated	Stainless steel	High corrosion resistance stainless steel (HCR)
Rod with inner threaded	Steel, property class 5.8 to 8.89 acc. to EN ISO 898-1 electroplated $\geq 5 \mu\text{m}$ acc. to EN ISO 4042 or hot-dip galvanized $\geq 45 \mu\text{m}$ acc. to EN ISO 10684	Steel 1.4401, 1.4404, 1.4571 acc. to EN 10088; property class 70 and 80 (A4-70 and A4-80) acc. to EN ISO 3506 acc. to EN ISO 3506 Corrosion resistance class CRC III acc. to EN 1993-1-4:2006 +A1:2015	Steel 1.4529, 1.4565, 1.4547 acc. to EN 10088; property class 70 acc. to EN ISO 3506 Corrosion resistance class CRC V acc. to EN 1993-1-4:2006 +A1:2015

**Table A3 : Reinforcing bars according to EN 1992-1-1, Annex C**

Product form	Bars and de-coiled rods	
Class	B	C
Characteristic yield strength $f_{yk}$ or $f_{0,2k}$ [ $\text{N}/\text{mm}^2$ ]	400 to 600	
Minimum value of $k = (f_t / f_y)_k$	$\geq 1.08$	$\geq 1.15$ < 1.35
Characteristic strain at maximum force, $\epsilon_{uk}$ [%]	$\geq 5.0$	$\geq 7.5$
Bendability	Bend / Rebind test	
Maximum deviation from nominal mass (individual bar) [%]	Nominal bar size [mm] $\leq 8$ $> 8$	$\pm 6.0$ $\pm 4.5$
Bond: minimum relative rib area, $f_{R,min}$	Nominal bar size [mm] 8 to 12 $> 12$	0.040 0.056

– Rib height h: The maximum rib height  $h_{rib}$  shall be:  $h_{rib} \leq 0.07 \cdot \emptyset$

**Table A4: Injection mortar**

Product	Composition
SEL-V400+ (two component injection mortar)	Additive: quartz Bonding agent: vinyl ester mortar styrene free Hardener: dibenzoyl peroxide

SEL-V400+

Product description  
Materials

Annex A4



## ANNEX A : Product description

Figure A4 : Cartridge types and sizes

**Coaxial cartridges**

150 ml, 280 ml, 300 ml, 310 ml, 330 ml, 380 ml, 400 ml, 410 ml, 420 ml.

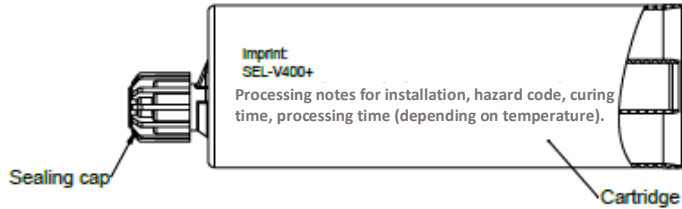

**Side by side cartridge**

345 ml, 425 ml, 825 ml

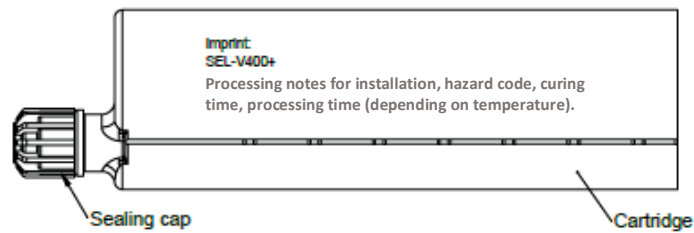

**Cartridge for two part foil capsules within a single components**

150 ml, 280 ml, 300 ml, 310 ml, 330 ml, 380 ml, 400 ml, 550 ml, 600 ml.

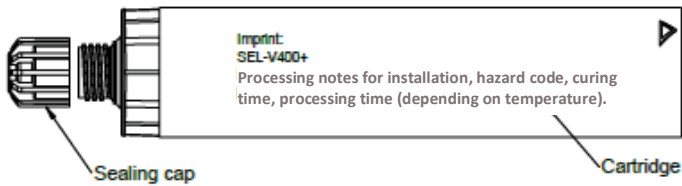

**Mixer for Cartridge**



**Foil capsule (CFS system)**

150 ml, 175 ml, 280 ml, 300 ml, 310 ml, 380 ml, 550 ml, 600 ml

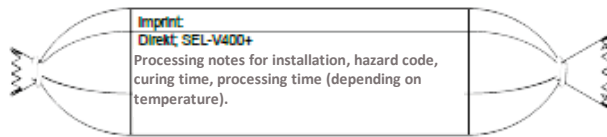

**Mixer for foil capsule (CFS system)**

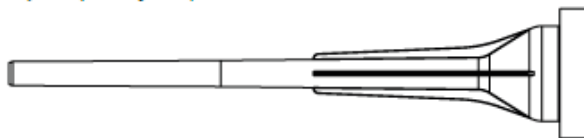

**Mixer standard plus adapter CFS+ for foil capsule**



SEL-V400+

Product description  
Cartridge types and sizes

Annex A5

## ANNEX B : Intended use

### Specification of intended use

#### Anchorage subject to:

Static and quasi-static loads: threaded rod size M8 to M30, rod with inner thread sizes M6/Ø10 to M16/Ø24 and rebar Ø8 to Ø32.

Seismic performance category C1: threaded rod size M8 to M30 and rebar Ø8 to Ø32

#### Base material:

- Reinforced or unreinforced normal weight concrete of strength class C20/25 to C50/60 according to EN 206 : 2013+A1 : 2016.
- Cracked and uncracked concrete.

#### Temperature ranges:

##### Installation temperature (temperature of substrate):

- -5°C to +40°C

##### In-service temperature:

The anchors may be used in the following temperature range:

- -40°C to +40°C (max. short term temperature +40°C and max. long term temperature +24°C).
- -40°C to +80°C (max. short term temperature +80°C and max. long term temperature +50°C).
- -40°C to +120°C (max. short term temperature +120°C and max. long term temperature +80°C).

##### Use conditions (environmental conditions):

- Structures subject to dry internal conditions: all materials.
- For all other conditions according to EN 1993-1-4 : 2006+A1 : 2015 corresponding to corrosion resistance class (CRC): elements made of stainless steel or high corrosion resistance stainless steel (HCR).

##### Installation:

- Dry or wet concrete (use category I1).
- Flooded holes (use category I2).
- Installation direction D3 (downward and horizontal and upwards installation).
- The anchors are suitable for hammer drilled holes or by special method with cleaning during the drilling of the hole using a hollow drill bit with vacuum cleaner.

##### Design methods:

- Anchorages under static or quasi-static loads are designed in accordance with EN 1992-4 : 2018 and EOTA Technical Report TR 055.
- Anchorages are designed under the responsibility of the engineer experienced in anchorages and concrete work.
- Verifiable calculation notes and drawings are prepared taking account of the loads to be anchored. The position of the anchor is indicated on the design drawings (e.g. position of the anchor relative to reinforcement or to supports, etc.).
- Anchorages under seismic actions (cracked concrete) have to be designed in accordance with EN 1992-4 : 2018.

SEL-V400+	
Intended use Specification	Annex B1

## ANNEX B : Intended use

Figure B1 : Installation parameters – threaded anchor rod

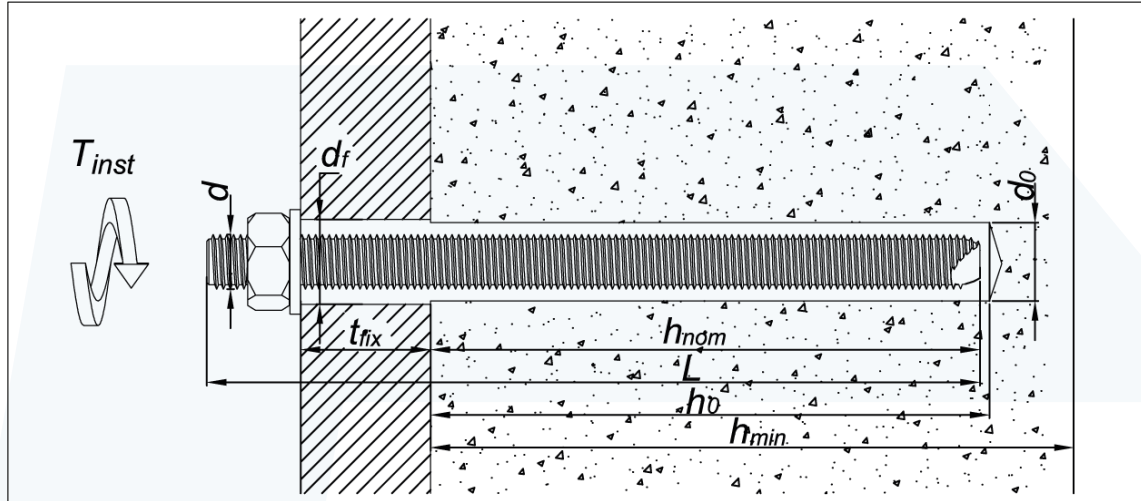

Table B1 : Installation parameters – threaded anchor rod

Size		M8	M10	M12	M16	M20	M24	M30	
Diameter of anchor rod	d [mm]	8	10	12	16	20	24	30	
Nominal drilling diameter	d <sub>0</sub> [mm]	10	12	14	18	24	28	35	
Maximum diameter hole in the fixture	d <sub>f</sub> [mm]	9	12	14	18	22	26	33	
Effective embedment depth	h <sub>ef,min</sub> [mm]	60	60	60	60	80	96	120	
	h <sub>ef,max</sub> [mm]	160	200	240	320	400	480	600	
Depth of the drilling hole	h <sub>0</sub> [mm]	h <sub>ef</sub> + 5 mm							
Minimum thickness of the concrete slab	h <sub>min</sub> [mm]	h <sub>ef</sub> + 30 mm; ≥ 100 mm				h <sub>ef</sub> + 2d <sub>0</sub>			
Maximum installation torque	T <sub>inst,max</sub> [N·m]	10	20	40	80	120	160	200	
Minimum spacing	S <sub>min</sub> [mm]	40	40	40	40	40	50	60	
Minimum edge distance	C <sub>min</sub> [mm]	40	40	40	40	40	50	60	

SEL-V400+

Intended use  
Installation parameters – threaded anchor rod

Annex B2

## ANNEX B : Intended use

Figure B2 : Installation parameters – anchor rod with inner thread

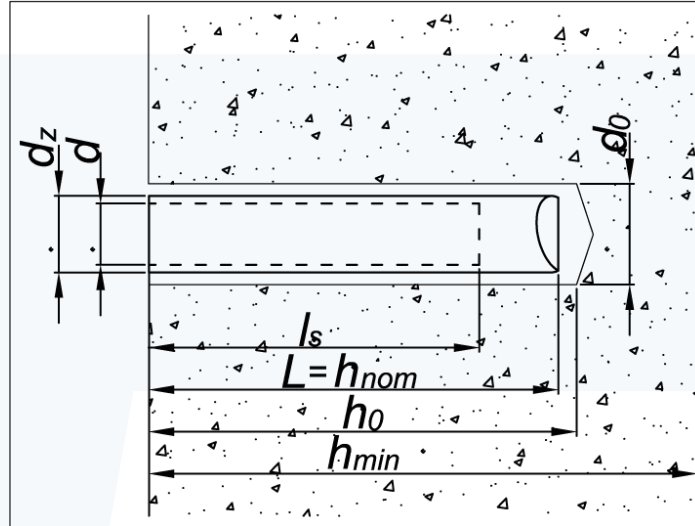

Table B2 : Installation parameters – anchor rod with inner thread

Size		M6/ Ø10 /75	M8/ Ø12/ 75	M8/ Ø12/ 90	M10/Ø16/ 75	M10/Ø16/ 100	M12/Ø16/ 100	M16/Ø24/ 125
Nominal drilling diameter	$d_0$ [mm]	12	14	14	20	20	20	28
Maximum diameter hole in the fixture	$d_f$ [mm]	7	9	9	12	12	14	18
Effective embedment depth	$h_{ef} = h_{nom}$ [mm]	75	75	90	75	100	100	125
Thread length, min	$l_s$ [mm]	24	25	25	30	30	35	50
Depth of the drilling hole	$h_0$ [mm]	$h_{ef} + 5 \text{ mm}$						
Minimum thickness of the concrete slab	$h_{min}$ [mm]	$h_{ef} + 30 \text{ mm}; \geq 100 \text{ mm}$				$h_{ef} + 2d_0$		
Maximum installation torque	$T_{inst,max}$ [N·m]	3	5	5	10	10	20	40
Minimum spacing	$s_{min}$ [mm]	40	40	50	40	50	50	70
Minimum edge distance	$c_{min}$ [mm]	40	40	50	40	50	50	70

SEL-V400+

Intended use  
Installation parameters – anchor rod with inner thread

Annex B3

## ANNEX B : Intended use

Figure B3 : Installation parameters – rebar

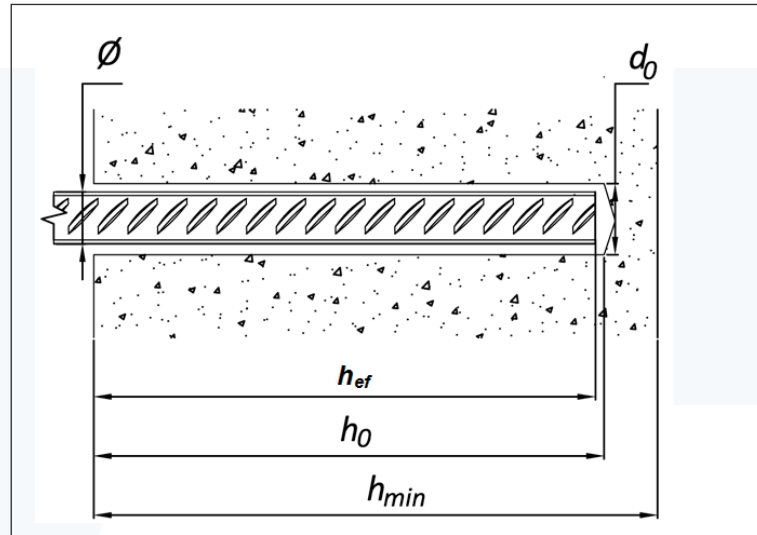

Table B3 : Installation parameters – rebar

Size		Ø8	Ø10	Ø12	Ø14	Ø16	Ø20	Ø25	Ø32
Nominal drilling diameter	$d_0$ [mm]	12	14	18	18	22	26	32	40
Effective embedment depth	$h_{ef,min}$ [mm]	60	60	60	60	64	80	100	128
	$h_{ef,max}$ [mm]	160	200	240	240	320	400	500	640
Depth of the drilling hole	$h_0$ [mm]	$h_{ef} + 5$ mm							
Minimum thickness of the concrete slab	$h_{min}$ [mm]	$h_{ef} + 30$ mm; $\geq 100$ mm				$h_{ef} + 2d_0$			
Minimum spacing	$s_{min}$ [mm]	40	40	40	40	40	40	50	70
Minimum edge distance	$c_{min}$ [mm]	40	40	40	40	40	40	50	70

SEL-V400+

Intended use  
Installation parameters – rebar

Annex B4

## ANNEX B : Intended use

**Table B4 : Maximum processing time and minimum curing time**

SEL-V400+			
Temperature of mortar [°C]	Temperature of substrate [°C]	Maximum processing (open) time [min]	Minimum curing time <sup>1)</sup> [min]
+5	-5	40	1440
+5	0	30	180
+5	+5	15	90
+10	+10	8	60
+15	+15	5	60
+20	+20	2.5	45
+25	+25	2	45
+25	+30	2	45
+25	+35	1.5	30
+25	+40	1.5	30

<sup>1)</sup> The minimum time from the end of the mixing to the time when the anchor may be torque or loaded (whichever is longer). Minimum mortar temperature for installation +5°C; maximum mortar temperature for installation +25°C. For wet conditions and flooded holes the curing time must be doubled.

SEL-V400+

Intended use  
Maximum processing time and minimum curing time

Annex B5

## ANNEX B : Intended use

Figure B4 : Installation tools

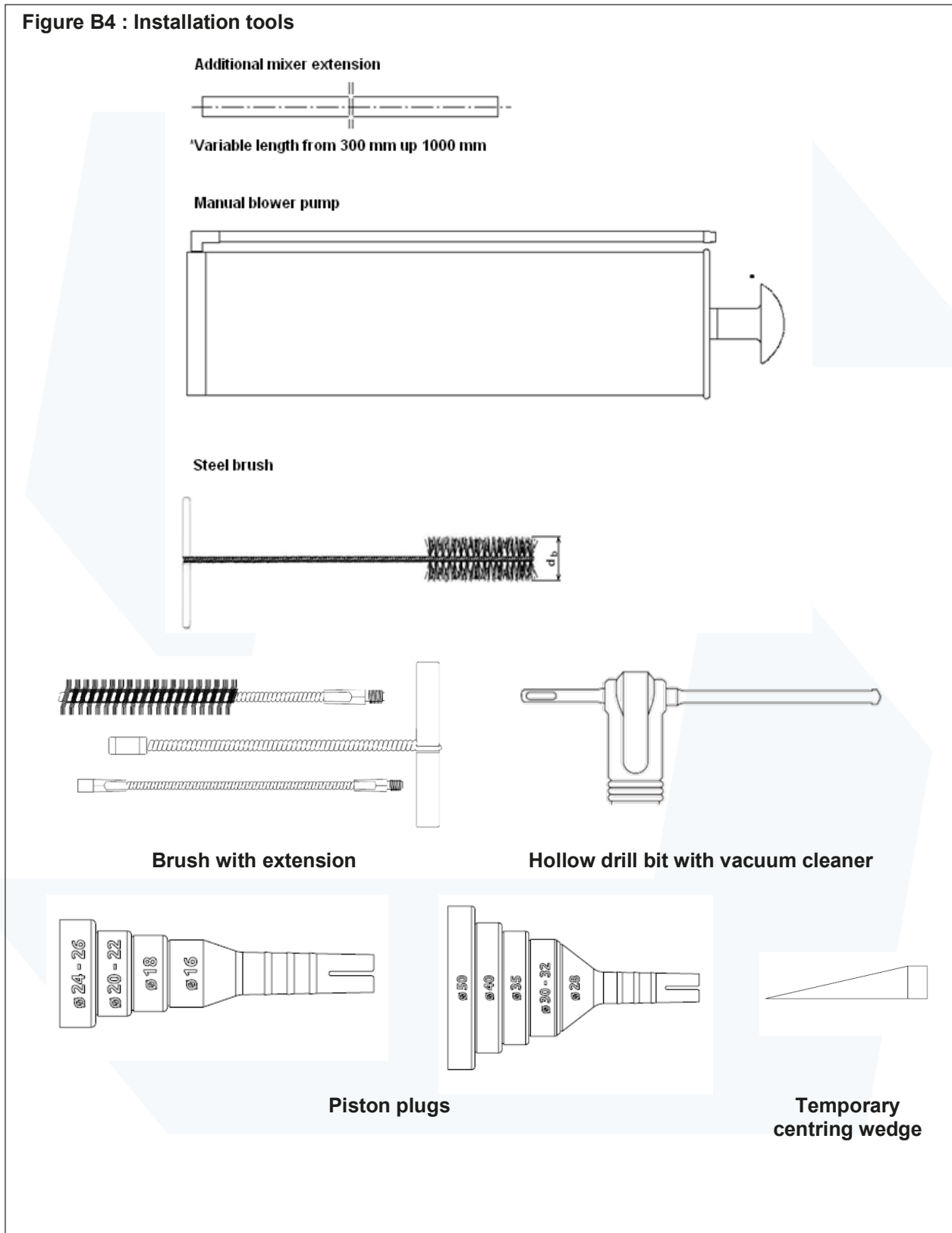

SEL-V400+	Annex B6
Intended use Tools (1)	

**ANNEX B : Intended use**

**Figure B5 : Installation tools - dispensers**

Dispensers	Cartridge or foil capsule size
 <p>Manual gun for coaxial cartridges</p>	380, 400, 410 and 420 ml
 <p>Manual gun for side by side cartridges</p>	345 ml
 <p>Manual gun for foil capsule in cartridge and coaxial cartridges</p>	150, 175, 280, 300 and 310 ml
 <p>Manual gun for foil capsules CFS+</p>	300 to 600 ml
 <p>Cordless dispenser gun for coaxial cartridges</p>	380, 400, 410 and 420 ml
 <p>Cordless dispenser gun for foil capsules</p>	300 to 600 ml
 <p>Pneumatic gun for coaxial cartridges</p>	380, 400, 410 and 420 ml

SEL-V400+

Intended use  
Tools (2)

Annex B7



## ANNEX B : Intended use

**Table B5 : Brush diameter for threaded rod**

Threaded rod diameter			M8	M10	M12	M16	M20	M24	M30
<b>d<sub>b</sub></b>	Brush diameter	[mm]	12	14	16	20	26	30	37

**Table B6 : Standard brush diameter for rod with inner thread**

Threaded rod diameter			M6/Ø10	M8/Ø12	M10/Ø16	M12/ Ø16	M16/Ø24
<b>d<sub>b</sub></b>	Brush diameter	[mm]	16	16	22	22	30

**Table B7 : Brush diameter for rebar**

Rebar diameter			Ø8	Ø10	Ø12	Ø14	Ø16	Ø20	Ø25	Ø32
<b>d<sub>b</sub></b>	Brush diameter	[mm]	14	16	20	20	24	28	37	42

**Table B8 : Piston plug size**

Hole diameter [mm]	16	18	20	22	24	25	26	28	30	32	35	40	50
Piston plug description	Ø16	Ø18	Ø20 to Ø22		Ø24 to Ø26			Ø28	Ø30 to Ø32		Ø35	Ø40	Ø50





SEL-V400+

Intended use  
Tools (3)

Annex B8

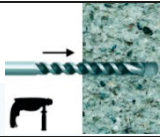
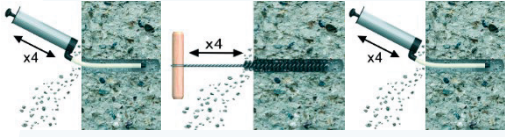
## ANNEX B : Intended use

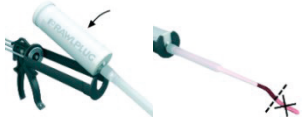
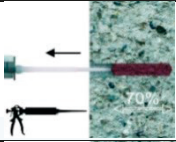
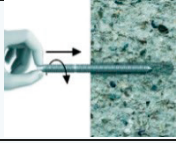
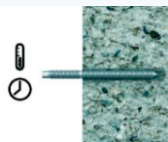
**Figure B6 : Installation instruction – threaded rod – standard cleaning**

	<ol style="list-style-type: none"> <li>1. Drill hole to the required diameter and depth using a rotary percussive machine</li> </ol>
<p>a.</p>  <p>b.</p> 	<ol style="list-style-type: none"> <li>2. Hole cleaning.             <ol style="list-style-type: none"> <li>a. Clean the hole with brush and hand pump:                 <ul style="list-style-type: none"> <li>- starting from the drill hole bottom blow the hole at least 4 times using the hand pump,</li> <li>- using the specified brush, mechanically brush out the hole at least 4 times,</li> <li>- starting from the drill hole bottom, blow at least 4 times with the hand pump.</li> </ul> </li> <li>b. Cleaning hole with compressed air:                 <ul style="list-style-type: none"> <li>- starting from the drill hole bottom blow the hole at least twice by compressed air (6 atm),</li> <li>- using the specified brush, mechanically brush out the hole at least twice,</li> <li>- blow the hole at least twice by compressed air (6atm),</li> <li>- brush out the hole at least twice,</li> <li>- blow over the hole at least twice by compressed air (6atm).</li> </ul> </li> </ol> </li> </ol>
	<ol style="list-style-type: none"> <li>3. Insert cartridge into dispenser and attach nozzle. Dispense to waste until even colour is obtained (min. 10 cm).</li> </ol>
	<ol style="list-style-type: none"> <li>4. Insert the mixing nozzle to the far end of the hole and inject mortar, slowly withdrawing the nozzle as the hole is filled to 2/3 of its depth.</li> </ol>
	<ol style="list-style-type: none"> <li>5. Immediately insert the stud, slowly and with slight twisting motion. Remove any excess mortar around the hole before it sets.</li> </ol>
	<ol style="list-style-type: none"> <li>6. Leave the fixing undisturbed until the curing time elapses.</li> </ol>
	<ol style="list-style-type: none"> <li>7. Attach fixture and tighten the nut to the required installation torque. The applied installation torque cannot exceed <math>T_{inst,max}</math>.</li> </ol>





SEL-V400+

Intended use  
Installation instruction – threaded rod – standard cleaning

Annex B9

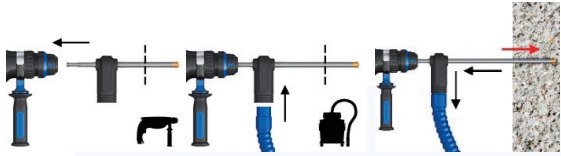
## ANNEX B : Intended use

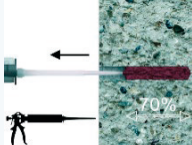
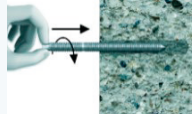
**Figure B7 : Installation instruction – threaded rod – cleaning with hollow drill bit**

	<p>1. Drill hole to the required diameter and depth using a hollow drill bit with vacuum cleaner.</p>
	<p>2. Insert cartridge into dispenser and attach nozzle. Dispense to waste until even colour is obtained.</p>
	<p>3. Insert the mixing nozzle to the far end of the hole and inject mortar, slowly withdrawing the nozzle as the hole is filled to 2/3 of its depth.</p>
	<p>4. Immediately insert the stud, slowly and with slight twisting motion. Remove any excess mortar around the hole before it sets.</p>
	<p>5. Leave the fixing undisturbed until the curing time elapses.</p>
	<p>6. Attach fixture and tighten the nut to the required installation torque. The applied installation torque cannot exceed <math>T_{inst,max}</math>.</p>

SEL-V400+

Intended use  
Installation instruction – threaded rod – cleaning with hollow drill bit (special cleaning method)

Annex B10

## ANNEX B : Intended use

Figure B8 : Installation instruction – threaded rod – overhead installation

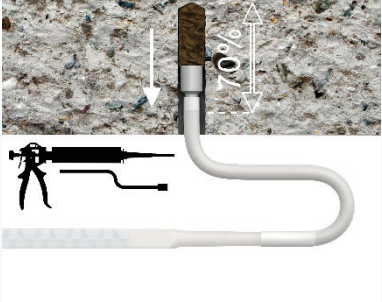
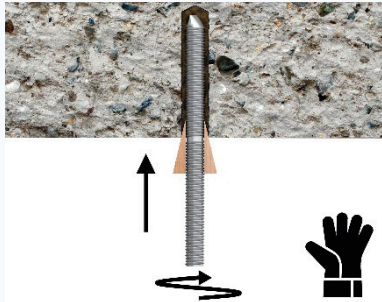
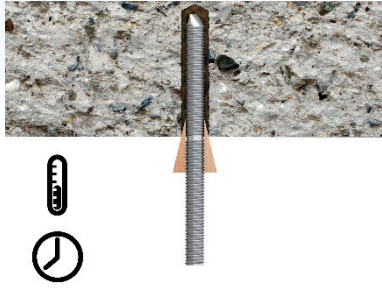
	<ol style="list-style-type: none"> <li>1. Inject from the bottom of the hole. Inject the mortar about 2/3 of the hole depth. For best performance use extension and appropriately sized piston plug assembled on the mixer.</li> </ol>
	<ol style="list-style-type: none"> <li>2. Drive the stud immediately into the hole. Use temporary interlocking element.</li> </ol>
	<ol style="list-style-type: none"> <li>3. Leave the fixing undisturbed until the curing time elapses. To avoid the slipping of the stud during the open time of the product (due to the stud own weight) use a temporary interlocking element.</li> </ol>



SEL-V400+

Intended use  
Installation instruction – threaded rod – overhead installation

Annex B11

## ANNEX B : Intended use

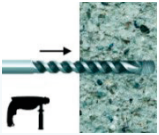
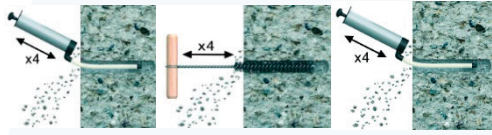
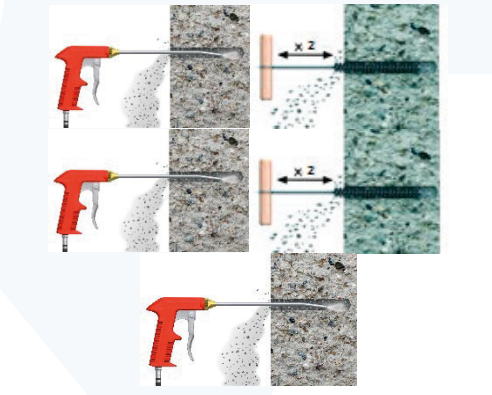
Figure B9 : Installation instruction – anchor rod with inner thread – standard cleaning

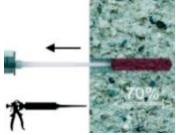
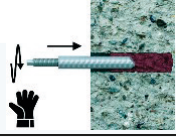
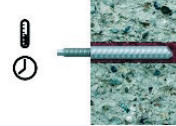
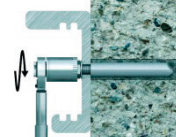
	<p>1. Drill hole to the required diameter and depth using a rotary percussive machine.</p>
<p>a.</p>  <p>b.</p> 	<p>2. Hole cleaning.</p> <p>a. Clean the hole with brush and hand pump:</p> <ul style="list-style-type: none"> <li>- starting from the drill hole bottom blow the hole at least 4 times using the hand pump,</li> <li>- using the specified brush, mechanically brush out the hole at least 4 times,</li> <li>- starting from the drill hole bottom, blow at least 4 times with the hand pump.</li> </ul> <p>b. Cleaning hole with compressed air:</p> <ul style="list-style-type: none"> <li>- starting from the drill hole bottom blow the hole at least twice by compressed air (6 atm),</li> <li>- using the specified brush, mechanically brush out the hole at least twice,</li> <li>- blow the hole at least twice by compressed air (6 atm),</li> <li>- brush out the hole at least twice,</li> <li>- blow over the hole at least twice by compressed air (6 atm).</li> </ul>
	<p>3. Insert cartridge into dispenser and attach nozzle. Dispense to waste until even colour is obtained (min. 10 cm).</p>
	<p>4. Insert the mixing nozzle to the far end of the hole and inject mortar, slowly withdrawing the nozzle as the hole is filled to 2/3 of its depth.</p>
	<p>5. Immediately insert the rod with inner thread, slowly and with slight twisting motion. Remove any excess mortar around the hole before it sets.</p>
	<p>6. Leave the fixing undisturbed until the curing time elapses.</p>
	<p>7. Attach fixture and tighten the bolt to the required installation torque. The applied installation torque cannot exceed <math>T_{inst,max}</math>.</p>



SEL-V400+

Intended use  
Installation instruction – anchor rod with inner thread – standard cleaning

Annex B12

## ANNEX B : Intended use

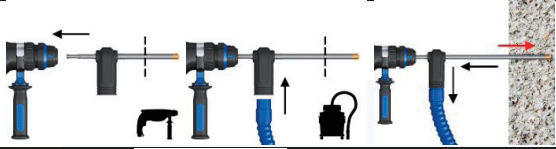
Figure B10 : Installation instruction – anchor rod with inner thread – cleaning with hollow drill bit

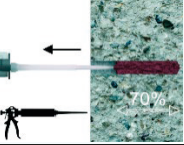
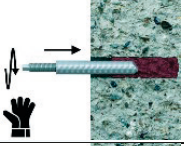
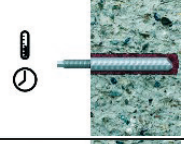
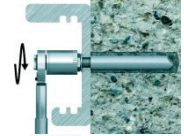
	<p>1. Drill hole to the required diameter and depth using a hollow drill bit with vacuum cleaner.</p>
	<p>2. Insert cartridge into dispenser and attach nozzle. Dispense to waste until even colour is obtained (min. 10 cm).</p>
	<p>3. Insert the mixing nozzle to the far end of the hole and inject mortar, slowly withdrawing the nozzle as the hole is filled to 2/3 of its depth.</p>
	<p>4. Immediately insert the rod with inner thread, slowly and with slight twisting motion. Remove any excess mortar around the hole before it sets.</p>
	<p>5. Leave the fixing undisturbed until the curing time elapses.</p>
	<p>6. Attach fixture and tighten the bolt to the required installation torque. The applied installation torque cannot exceed <math>T_{inst,max}</math>.</p>





SEL-V400+

Intended use  
Installation instruction – anchor rod with inner thread – cleaning with hollow drill bit (special cleaning method)

Annex B13

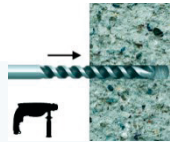
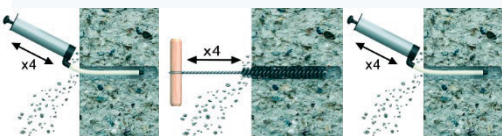
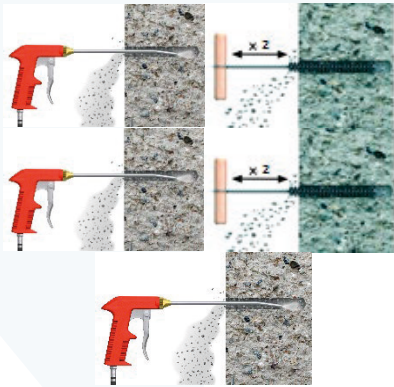

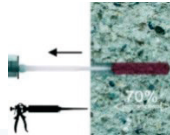
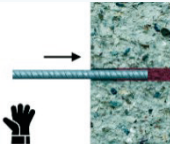
## ANNEX B : Intended use

Figure B11 : Installation instruction – rebar – standard cleaning

	<ol style="list-style-type: none"> <li>1. Drill hole to the required diameter and depth using a rotary percussive machine.</li> </ol>
<p>a.</p>  <p>b.</p> 	<ol style="list-style-type: none"> <li>2. Hole cleaning.             <ol style="list-style-type: none"> <li>a. Cleaning hole with brush and hand pump:                 <ul style="list-style-type: none"> <li>- starting from the drill hole bottom blow the hole at least 4 times using the hand pump,</li> <li>- using the specified brush, mechanically brush out the hole at least 4 times,</li> <li>- starting from the drill hole bottom, blow at least 4 times with the hand pump.</li> </ul> </li> <li>1.                 <ol style="list-style-type: none"> <li>b. Cleaning hole with compressed air:                     <ul style="list-style-type: none"> <li>- starting from the drill hole bottom blow the hole at least twice by compressed air (6 atm),</li> <li>- using the specified brush, mechanically brush out the hole at least twice,</li> <li>- blow the hole at least twice by compressed air (6 atm),</li> <li>- brush out the hole at least twice,</li> <li>- blow over the hole at least twice by compressed air (6atm).</li> </ul> </li> </ol> </li> </ol> </li> </ol>
	<ol style="list-style-type: none"> <li>3. Insert cartridge into dispenser and attach nozzle. Dispense to waste until even colour is obtained (min. 10 cm).</li> </ol>
	<ol style="list-style-type: none"> <li>4. Insert the mixing nozzle to the far end of the hole and inject mortar, slowly withdrawing the nozzle as the hole is filled to 2/3 of its depth.</li> </ol>
	<ol style="list-style-type: none"> <li>5. Immediately insert the rebar, slowly and with slight twisting motion. Remove any excess mortar around the hole before it sets.</li> </ol>
	<ol style="list-style-type: none"> <li>6. Leave the fixing undisturbed until the curing time elapses.</li> </ol>
<p>SEL-V400+</p>	
<p>Intended use Installation instruction – rebar – standard cleaning</p> <p style="text-align: right;">Annex B14</p>	

## ANNEX B : Intended use

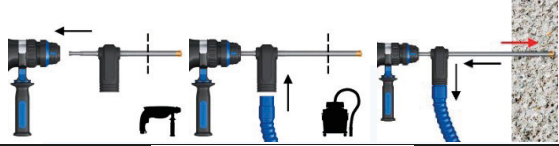
Figure B12 : Installation instruction – rebar – cleaning with hollow drill bit

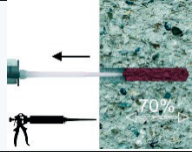
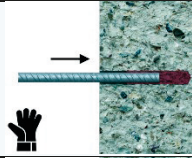
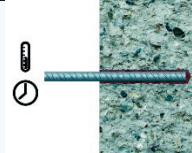
	<p>1. Drill hole to the required diameter and depth using a hollow drill bit with vacuum cleaner.</p>
	<p>2. Insert cartridge into dispenser and attach nozzle. Dispense to waste until even colour is obtained (min. 10 cm).</p>
	<p>3. Insert the mixing nozzle to the far end of the hole and inject mortar, slowly withdrawing the nozzle as the hole is filled to 2/3 of its depth.</p>
	<p>4. Immediately insert the rebar, slowly and with slight twisting motion. Remove any excess mortar around the hole before it sets.</p>
	<p>5. Leave the fixing undisturbed until the curing time elapses.</p>

SEL-V400+

Intended use  
Installation instruction – rebar – cleaning with hollow drill bit  
(special cleaning method)

Annex B15



## ANNEX B : Intended use

Figure B13 : Installation instruction – rebar – overhead installation

	<ol style="list-style-type: none"> <li>1. Inject from the bottom of the hole. Inject the mortar about 2/3 of the hole depth. For best performance use extension and appropriately sized piston plug assembled on the mixer.</li> </ol>
	<ol style="list-style-type: none"> <li>2. Drive the rebar immediately into the hole. Use temporary interlocking element.</li> </ol>
	<ol style="list-style-type: none"> <li>3. Leave the fixing undisturbed until the curing time elapses. To avoid the slipping of the rebar during the open time of the product (due to the rebar own weight) use a temporary interlocking element.</li> </ol>

SEL-V400+

Intended use  
Installation instruction – rebar – overhead installation

Annex B16

### ANNEX C : Performance

**Table C1: Characteristic resistance under tension load for threaded rod in uncracked concrete**

Size	M8	M10	M12	M16	M20	M24	M30		
<b>Steel failure</b>									
Steel failure with threaded rod grade 5.8									
Characteristic resistance	$N_{Rk,s}$	[kN]	18	29	42	78	122	176	280
Partial safety factor <sup>1)</sup>	$\gamma_{Ms}$	[-]	1.50						
Steel failure with threaded rod grade 8.8									
Characteristic resistance	$N_{Rk,s}$	[kN]	29	46	67	125	196	282	448
Partial safety factor <sup>1)</sup>	$\gamma_{Ms}$	[-]	1.50						
Steel failure with threaded rod grade 10.9									
Characteristic resistance	$N_{Rk,s}$	[kN]	36	58	84	157	245	353	561
Partial safety factor <sup>1)</sup>	$\gamma_{Ms}$	[-]	1.40						
Steel failure with threaded rod grade 12.9									
Characteristic resistance	$N_{Rk,s}$	[kN]	43	69	101	188	294	423	673
Partial safety factor <sup>1)</sup>	$\gamma_{Ms}$	[-]	1.40						
Steel failure with stainless steel threaded rod A4-70									
Characteristic resistance	$N_{Rk,s}$	[kN]	25	40	59	109	171	247	392
Partial safety factor <sup>1)</sup>	$\gamma_{Ms}$	[-]	1.87						
Steel failure with stainless steel threaded rod A4-80									
Characteristic resistance	$N_{Rk,s}$	[kN]	29	46	67	125	196	282	448
Partial safety factor <sup>1)</sup>	$\gamma_{Ms}$	[-]	1.60						
Steel failure with high corrosion resistant steel grade 70									
Characteristic resistance	$N_{Rk,s}$	[kN]	25	40	59	109	171	247	392
Partial safety factor <sup>1)</sup>	$\gamma_{Ms}$	[-]	1.87						
Steel failure with ultra-high strength steel threaded rod grade 14.8									
Characteristic resistance	$N_{Rk,s}$	[kN]	51	81	118	219	343	494	785
Partial safety factor <sup>1)</sup>	$\gamma_{Ms}$	[-]	1.5						
Steel failure with ultra-high strength steel threaded rod grade 15.8									
Characteristic resistance	$N_{Rk,s}$	[kN]	54	87	126	235	367	529	841
Partial safety factor <sup>1)</sup>	$\gamma_{Ms}$	[-]	1.5						
Steel failure with ultra-high strength steel threaded rod grade 16.8									
Characteristic resistance	$N_{Rk,s}$	[kN]	58	92	134.9	251	392	564	897
Partial safety factor <sup>1)</sup>	$\gamma_{Ms}$	[-]	1.5						
<b>Combined pull-out and concrete cone failure in uncracked concrete C20/25 for a working life of 50 years</b>									
Characteristic bond resistance									
Temperature range I: 24°C / 40°C	$\tau_{Rk,ucr,50}$	[N.mm <sup>-2</sup> ]	16.0	15.0	15.0	13.0	10.0	10.0	8.0
Temperature range II: 50°C / 80°C	$\tau_{Rk,ucr,50}$	[N.mm <sup>-2</sup> ]	16.0	15.0	15.0	13.0	10.0	10.0	8.0
Temperature range III: 80°C / 120°C	$\tau_{Rk,ucr,50}$	[N.mm <sup>-2</sup> ]	8.5	8.0	8.0	7.0	5.5	5.5	4.5
Increasing factor	$\psi_c$	C30/37	1.04						
		C40/50	1.07						
		C50/60	1.09						
Sustained load factor	$\psi_{sus}^0$	24°C/40°C	0.72						
		50°C/80°C	0.72						
		80°C/120°C	0.61						

SEL-V400+

Performance  
Characteristic resistance under tension loads for threaded rod in uncracked concrete

Annex C1

## ANNEX C : Performance

**Table C1 (continuation)**

Size			M8	M10	M12	M16	M20	M24	M30	
<b>Combined pull-out and concrete cone failure in uncracked concrete C20/25 for a working life of 100 years</b>										
Characteristic bond resistance										
Temperature range I: 24°C/40°C	$\tau_{RK,ucr,100}$	[N.mm <sup>-2</sup> ]	15.0	15.0	14.0	13.0	10.0	9.5	8.0	
Temperature range II: 50°C/80°C	$\tau_{RK,ucr,100}$	[N.mm <sup>-2</sup> ]	15.0	15.0	14.0	13.0	10.0	9.5	8.0	
Increasing factor	$\psi_c$	C30/37	1.04							
		C40/50	1.07							
		C50/60	1.09							
<b>Concrete cone failure in uncracked concrete</b>										
Factor for uncracked concrete	$k_{ucr,N}$	[-]	11.0							
Edge distance	$c_{ucr,N}$	[mm]	$1.5 \cdot h_{ef}$							
Spacing	$s_{ucr,N}$	[mm]	$3.0 \cdot h_{ef}$							
<b>Splitting failure</b>										
Edge distance	$c_{cr,sp}$ for $h_{min}$	[mm]	$2.0 \cdot h_{ef}$				$1.5 \cdot h_{ef}$			
	$c_{cr,sp}$ for $h_{min} < h^2 < 2 \cdot h_{ef}$ ( $c_{cr,sp}$ from linear interpolation)									
	$c_{cr,sp}$ for $h^2 \geq 2 \cdot h_{ef}$		$c_{cr,N}$							
Spacing	$s_{cr,sp}$	[mm]	$2.0 \cdot c_{cr,sp}$							
<b>Installation safety factor for combined pull-out, concrete cone and splitting failure</b>										
Installation safety factors for in use category I1	standard cleaning	$\gamma_{inst}$	[-]	1.0						
	special cleaning			1.2	1.0				1.2	
Installation safety factors for in use category I2	standard cleaning			1.0						
	special cleaning			1.2	1.0				1.2	

<sup>1)</sup> In the absence of other national regulation.

<sup>2)</sup> h – concrete member thickness.

SEL-V400+

Performance  
Characteristic resistance under tension loads for threaded rod  
in uncracked concrete

Annex C2

### ANNEX C : Performance

Table C2: Characteristic resistance under tension loads for threaded rod in cracked concrete									
Size			M8	M10	M12	M16	M20	M24	M30
<b>Steel failure</b>									
Steel failure with threaded rod grade 5.8									
Characteristic resistance	$N_{RK,s}$	[kN]	18	29	42	78	122	176	280
Partial safety factor <sup>1)</sup>	$\gamma_{Ms}$	[-]	1.50						
Steel failure with threaded rod grade 8.8									
Characteristic resistance	$N_{RK,s}$	[kN]	29	46	67	125	196	282	448
Partial safety factor <sup>1)</sup>	$\gamma_{Ms}$	[-]	1.50						
Steel failure with threaded rod grade 10.9									
Characteristic resistance	$N_{RK,s}$	[kN]	36	58	84	157	245	353	561
Partial safety factor <sup>1)</sup>	$\gamma_{Ms}$	[-]	1.40						
Steel failure with threaded rod grade 12.9									
Characteristic resistance	$N_{RK,s}$	[kN]	43	69	101	188	294	423	673
Partial safety factor <sup>1)</sup>	$\gamma_{Ms}$	[-]	1.40						
Steel failure with stainless steel threaded rod A4-70									
Characteristic resistance	$N_{RK,s}$	[kN]	25	40	59	109	171	247	392
Partial safety factor <sup>1)</sup>	$\gamma_{Ms}$	[-]	1.87						
Steel failure with stainless steel threaded rod A4-80									
Characteristic resistance	$N_{RK,s}$	[kN]	29	46	67	125	196	282	448
Partial safety factor <sup>1)</sup>	$\gamma_{Ms}$	[-]	1.60						
Steel failure with high corrosion resistant steel grade 70									
Characteristic resistance	$N_{RK,s}$	[kN]	25	40	59	109	171	247	392
Partial safety factor <sup>1)</sup>	$\gamma_{Ms}$	[-]	1.87						
Steel failure with ultra-high strength steel threaded rod grade 14.8									
Characteristic resistance	$N_{RK,s}$	[kN]	51	81	118	219	343	494	785
Partial safety factor <sup>1)</sup>	$\gamma_{Ms}$	[-]	1.5						
Steel failure with ultra-high strength steel threaded rod grade 15.8									
Characteristic resistance	$N_{RK,s}$	[kN]	54	87	126	235	367	529	841
Partial safety factor <sup>1)</sup>	$\gamma_{Ms}$	[-]	1.5						
Steel failure with ultra-high strength steel threaded rod grade 16.8									
Characteristic resistance	$N_{RK,s}$	[kN]	58	92	134.9	251	392	564	897
Partial safety factor <sup>1)</sup>	$\gamma_{Ms}$	[-]	1.5						
<b>Combined pull-out and concrete cone failure in cracked concrete C20/25 for a working life of 50 years</b>									
Characteristic bond resistance									
Temperature range I:24°C/40°C	$\tau_{RK,cr,50}$	[N.mm <sup>-2</sup> ]	10.0	11.0	11.0	9.5	7.5	7.0	5.0
Temperature range II:50°C/80°C	$\tau_{RK,cr,50}$	[N.mm <sup>-2</sup> ]	10.0	11.0	11.0	9.5	7.5	7.0	5.0
Temperature range III:80°C/120°C	$\tau_{RK,cr,50}$	[N.mm <sup>-2</sup> ]	5.0	6.0	6.0	5.0	4.0	4.0	3.0
Increasing factor	$\psi_c$	C30/37	1.04						
		C40/50	1.07						
		C50/60	1.09						
Sustained load factor	$\psi^0_{sus}$	24°C/40°C	0.72						
		50°C/80°C	0.72						
		80°C/120°C	0.61						
SEL-V400+								Annex C3	
Performance Characteristic resistance under tension loads for threaded rod in cracked concrete									

## ANNEX C : Performance

Table C2 (continuation)

Size	M8	M10	M12	M16	M20	M24	M30		
<b>Combined pull-out and concrete cone failure in cracked concrete C20/25 for a working life of 100 years</b>									
Characteristic bond resistance									
Temperature range I: 24°C / 40°C	$\tau_{Rk,ucr.10}$ <sub>0</sub>	[N.mm <sup>-2</sup> ]	9.5	10.0	10.5	9.5	7.5	7.0	5.0
Temperature range II: 50°C / 80°C	$\tau_{Rk,ucr.10}$ <sub>0</sub>	[N.mm <sup>-2</sup> ]	9.5	10.0	10.5	9.5	7.5	7.0	5.0
Increasing factor	$\psi_c$	C30/37	1.04						
		C40/50	1.07						
		C50/60	1.09						
<b>Concrete cone failure in cracked concrete</b>									
Factor for cracked concrete	$k_{cr,N}$	[-]	7.7						
Edge distance	$c_{cr,N}$	[mm]	1.5 · h <sub>ef</sub>						
Spacing	$s_{cr,N}$	[mm]	3.0 · h <sub>ef</sub>						
<b>Splitting failure</b>									
Edge distance	$c_{cr,sp}$ for h <sub>min</sub>	[mm]	2.0 · h <sub>ef</sub>			1.5 · h <sub>ef</sub>			
	$c_{cr,sp}$ for h <sub>min</sub> < h <sup>2)</sup> < 2 · h <sub>ef</sub> ( $c_{cr,sp}$ from linear interpolation)								
	$c_{cr,sp}$ for h <sup>2)</sup> ≥ 2 · h <sub>ef</sub>		c <sub>cr,N</sub>						
Spacing	$s_{cr,sp}$	[mm]	2.0 · c <sub>cr,sp</sub>						
<b>Installation safety factor for combined pull-out, concrete cone and splitting failure</b>									
Installation safety factors for in use category I1	standard cleaning	$\gamma_{inst}$	[-]	1.0					
	special cleaning			1.2	1.0				1.2
Installation safety factors for in use category I2	standard cleaning			1.0					
	special cleaning			1.2	1.0				1.2

<sup>1)</sup> In the absence of other national regulation.

<sup>2)</sup> h – concrete member thickness.

SEL-V400+

Performance  
Characteristic resistance under tension loads for threaded rod  
in cracked concrete

Annex C4

## ANNEX C : Performance

**Table C3: Characteristic resistance under tension load for rod with inner thread in uncracked concrete**

Size			M6 /Ø10	M8/ Ø12	M10/ Ø16	M12/ Ø16	M16/ Ø24
<b>Steel failure</b>							
Steel failure with rod with inner thread grade 5.8							
Characteristic resistance	$N_{Rk,s}$	[kN]	10	18	29	42	78
Partial safety factor <sup>1)</sup>	$\gamma_{Ms}$	[-]	1.50				
Steel failure with rod with inner thread grade 8.8							
Characteristic resistance	$N_{Rk,s}$	[kN]	16	29	46	67	125
Partial safety factor <sup>1)</sup>	$\gamma_{Ms}$	[-]	1.50				
Steel failure with stainless steel rod with inner thread threaded rod A4-70							
Characteristic resistance	$N_{Rk,s}$	[kN]	14	25	40	59	109
Partial safety factor <sup>1)</sup>	$\gamma_{Ms}$	[-]	1.87				
Steel failure with stainless steel rod with inner thread A4-80							
Characteristic resistance	$N_{Rk,s}$	[kN]	16	29	46	67	125
Partial safety factor <sup>1)</sup>	$\gamma_{Ms}$	[-]	1.60				
Steel failure with high corrosion resistant steel grade 70							
Characteristic resistance	$N_{Rk,s}$	[kN]	14	25	40	59	109
Partial safety factor <sup>1)</sup>	$\gamma_{Ms}$	[-]	1.87				
<b>Combined pull-out and concrete cone failure in uncracked concrete C20/25 for a working life of 50 years</b>							
Temperature range I: 24°C/40°C	$\tau_{Rk,ucr,50}$	[N.mm <sup>-2</sup> ]	11.0	14.0	11.0	11.0	8.0
Temperature range II: 50°C/80°C	$\tau_{Rk,ucr,50}$	[N.mm <sup>-2</sup> ]	11.0	14.0	11.0	11.0	8.0
Temperature range III: 80°C/120°C	$\tau_{Rk,ucr,50}$	[N.mm <sup>-2</sup> ]	6.0	7.0	6.0	6.0	4.0
Increasing factor	$\psi_c$	C30/37	1.04				1.00
		C40/50	1.07				1.00
		C50/60	1.09				1.00
Sustained load factor	$\psi_{sus}^0$	24°C/40°C	0.72				
		50°C/80°C	0.72				
		80°C / 120°C	0.61				
<b>Combined pull-out and concrete cone failure in uncracked concrete C20/25 for a working life of 100 years</b>							
Temperature range I: 24°C/40°C	$\tau_{Rk,ucr,100}$	[N.mm <sup>-2</sup> ]	10.0	13.0	10.0	11.0	8.0
Temperature range II: 50°C/80°C	$\tau_{Rk,ucr,100}$	[N.mm <sup>-2</sup> ]	10.0	13.0	10.0	11.0	8.0
Increasing factor	$\psi_c$	C30/37	1.04				1.00
		C40/50	1.07				1.00
		C50/60	1.09				1.00

SEL-V400+

Performance  
Characteristic resistance under tension loads for rod with inner thread  
in uncracked concrete

Annex C5

## ANNEX C : Performance

**Table C3: (continuation)**

<b>Resistance to concrete cone failure in uncracked concrete</b>				
Factor for uncracked concrete	$K_{ucr,N}$	[-]	11.0	
Edge distance	$C_{ucr,N}$	[mm]	$1.5 \cdot h_{ef}$	
Spacing	$S_{ucr,N}$	[mm]	$3.0 \cdot h_{ef}$	
<b>Splitting failure</b>				
Edge distance	$C_{cr,sp}$ for $h_{min}$	[mm]	$2.0 \cdot h_{ef}$	$1.5 \cdot h_{ef}$
	$C_{cr,sp}$ for $h_{min} < h^2 < 2 \cdot h_{ef}$ ( $C_{cr,sp}$ from linear interpolation)			
	$C_{cr,sp}$ for $h^2 \geq 2 \cdot h_{ef}$		$C_{cr,N}$	
Spacing	$S_{cr,sp}$	[mm]	$2.0 \cdot C_{cr,sp}$	
<b>Installation safety factor for combined pull-out, concrete cone and splitting failure</b>				
Installation safety factors for use category I1 <sup>1)</sup>	standard cleaning	$\gamma_{inst}$	[-]	1.0
	special cleaning			1.0
Installation safety factors for use category I2 <sup>1)</sup>	standard cleaning			1.0
	special cleaning			1.0

<sup>1)</sup> In the absence of other national regulation.

<sup>2)</sup> h – concrete member thickness.

SEL-V400+

Performance  
Characteristic resistance under tension loads for rod with inner thread in uncracked concrete

Annex C5

## ANNEX C : Performance

**Table C4: Characteristic resistance under tension loads for rod with inner thread in cracked concrete**

Size			M6/ Ø10	M8/ Ø12	M10/ Ø16	M12/ Ø16	M16/ Ø24
<b>Steel failure</b>							
Steel failure with rod with inner thread grade 5.8							
Characteristic resistance	$N_{Rk,s}$	[kN]	10	18	29	42	78
Partial safety factor <sup>1)</sup>	$\gamma_{Ms}$	[-]	1.50				
Steel failure with rod with inner thread grade 8.8							
Characteristic resistance	$N_{Rk,s}$	[kN]	16	29	46	67	125
Partial safety factor <sup>1)</sup>	$\gamma_{Ms}$	[-]	1.50				
Steel failure with stainless steel rod with inner thread A4-70							
Characteristic resistance	$N_{Rk,s}$	[kN]	14	25	40	59	109
Partial safety factor <sup>1)</sup>	$\gamma_{Ms}$	[-]	1.87				
Steel failure with stainless steel rod with inner thread rod A4-80							
Characteristic resistance	$N_{Rk,s}$	[kN]	16	29	46	67	125
Partial safety factor <sup>1)</sup>	$\gamma_{Ms}$	[-]	1.60				
Steel failure with high corrosion resistant steel grade 70							
Characteristic resistance	$N_{Rk,s}$	[kN]	14	25	40	59	109
Partial safety factor <sup>1)</sup>	$\gamma_{Ms}$	[-]	1.87				
<b>Combined pull-out and concrete cone failure in cracked concrete C20/25 for a working life of 50 years</b>							
Temperature range I: 24°C/40°C	$\tau_{Rk,cr.50}$	[N.mm <sup>-2</sup> ]	10.0	10.0	9.5	9.0	4.0
Temperature range II: 50°C/80°C	$\tau_{Rk,cr.50}$	[N.mm <sup>-2</sup> ]	10.0	10.0	9.5	9.0	4.0
Temperature range III: 80°C/120°C	$\tau_{Rk,cr.50}$	[N.mm <sup>-2</sup> ]	5.0	6.0	5.0	5.0	2.0
Increasing factor	$\psi_c$	C30/37	1.04				1.00
		C40/50	1.07				1.00
		C50/60	1.09				1.00
Sustained load factor	$\psi_{sus}^0$	24°C/40°C	0.72				
		50°C/80°C	0.72				
		80°C / 120°C	0.61				
<b>Combined pull-out and concrete cone failure in cracked concrete C20/25 for a working life of 100 years</b>							
Temperature range I: 24°C/40°C	$\tau_{Rk,cr.100}$	[N.mm <sup>-2</sup> ]	7.0	9.5	9.0	8.5	4.0
Temperature range II: 50°C/80°C	$\tau_{Rk,cr.100}$	[N.mm <sup>-2</sup> ]	7.0	9.5	9.0	8.5	4.0
Increasing factor	$\psi_c$	C30/37	1.04				1.00
		C40/50	1.07				1.00
		C50/60	1.09				1.00

SEL-V400+

Performance  
Characteristic resistance under tension loads for rod with inner thread  
in cracked concrete

Annex C6



## ANNEX C : Performance

**Table C4: (continuation)**

<b>Cone failure in cracked concrete</b>				
Factor for cracked concrete	$k_{Cr,N}$	[-]	7.7	
Edge distance	$C_{Cr,N}$	[mm]	$1.5 \cdot h_{ef}$	
Spacing	$S_{Cr,N}$	[mm]	$3.0 \cdot h_{ef}$	
<b>Splitting failure</b>				
Edge distance	$C_{Cr,sp}$ for $h_{min}$	[mm]	$2.0 \cdot h_{ef}$	$1.5 \cdot h_{ef}$
	$C_{Cr,sp}$ for $h_{min} < h^2) < 2 \cdot h_{ef}$ ( $C_{Cr,sp}$ from linear interpolation)			
	$C_{Cr,sp}$ for $h^2) \geq 2 \cdot h_{ef}$			
Spacing	$S_{Cr,sp}$	[mm]	$2.0 \cdot C_{Cr,sp}$	
<b>Installation safety factor for combined pull-out, concrete cone and splitting failure</b>				
Installation safety factors for use category I1	standard cleaning	$\gamma_{inst}$	[-]	1.0
	special cleaning			1.0
Installation safety factors for use category I2	standard cleaning			1.0
	special cleaning			1.0
SEL-V400+				Annex C6
Performance Characteristic resistance under tension loads for rod with inner thread in cracked concrete				

<sup>1)</sup> In the absence of other national regulation.

<sup>2)</sup>  $h$  – concrete member thickness.

### ANNEX C : Performance

**Table C5: Characteristic resistance under tension load for rebar in uncracked concrete**

Size		Ø8	Ø10	Ø12	Ø14	Ø16	Ø20	Ø25	Ø32	
Steel failure with rebar										
Characteristic resistance	$N_{Rk,s}$	[kN]	$A_s^3) \cdot f_{uk}^4)$							
Partial safety factor <sup>1)</sup>	$\gamma_{Ms}$	[-]	1.40							
<b>Combined pull-out and concrete cone failure in uncracked concrete C20/25 for a working life of 50 years</b>										
Temperature range I: 24°C/40°C	$\tau_{Rk,ucr.50}$	[N.mm <sup>-2</sup> ]	13.0	14.0	14.0	13.0	13.0	10.0	9.0	7.5
Temperature range II: 50°C/80°C	$\tau_{Rk,ucr.50}$	[N.mm <sup>-2</sup> ]	13.0	14.0	14.0	13.0	13.0	10.0	9.0	7.5
Temperature range III: 80°C/120°C	$\tau_{Rk,ucr.50}$	[N.mm <sup>-2</sup> ]	7.0	7.0	7.0	7.0	7.0	5.5	5.0	4.0
Increasing factor	$\psi_c$	C30/37	1.04							
		C40/50	1.07							
		C50/60	1.09							
Sustained load factor	$\psi_{sus}^0$	24°C/40°C	0.72							
		50°C/80°C	0.72							
		80°C/120°C	0.61							
<b>Combined pull-out and concrete cone failure in uncracked concrete C20/25 for a working life of 100 years</b>										
Temperature range I: 24°C / 40°C	$\tau_{Rk,ucr.100}$	[N.mm <sup>-2</sup> ]	12.0	14.0	14.0	12.0	12.0	10.0	8.5	7.5
Temperature range II: 50°C / 80°C	$\tau_{Rk,ucr.100}$	[N.mm <sup>-2</sup> ]	12.0	14.0	14.0	12.0	12.0	10.0	8.5	7.5
Increasing factor	$\psi_c$	C30/37	1.04							
		C40/50	1.07							
		C50/60	1.09							
<b>Concrete cone failure in uncracked concrete</b>										
Factor for non-cracked concrete	$k_{ucr.N}$	[-]	11.0							
Edge distance	$C_{ucr.N}$	[mm]	$1.5 \cdot h_{ef}$							
Spacing	$S_{ucr.N}$	[mm]	$3.0 \cdot h_{ef}$							
<b>Splitting failure</b>										
Edge distance	$C_{cr.sp}$ for $h_{min}$	[mm]	$2.0 \cdot h_{ef}$				$1.5 \cdot h_{ef}$			
	$C_{cr.sp}$ for $h_{min} < h^2) < 2 \cdot h_{ef}$ ( $C_{cr.sp}$ from linear interpolation)									
	$C_{cr.sp}$ for $h^2) \geq 2 \cdot h_{ef}$		$C_{cr.N}$							
Spacing	$S_{cr.sp}$	[mm]	$2.0 \cdot C_{cr.sp}$							
<b>Installation safety factor for combined pull-out, concrete cone and splitting failure</b>										
Installation safety factors for use category I1	standard cleaning	$\gamma_{inst}$	[-]	1.0						
	special cleaning			1.2	1.0				1.2	
Installation safety factors for use category I2	standard cleaning			1.2						
	special cleaning			1.2	1.0				1.2	
<sup>1)</sup> In the absence of other national regulation. <sup>2)</sup> h – concrete member thickness. <sup>3)</sup> Stressed cross section of the steel. <sup>4)</sup> Acc. to EN 1992-1-1.										
SEL-V400+								Annex C7		
Performance Characteristic resistance under tension loads for rebar in uncracked concrete										

### ANNEX C : Performance

**Table C6: Characteristic resistance under tension loads for rebar in cracked concrete**

Size			Ø8	Ø10	Ø12	Ø14	Ø16	Ø20	Ø25	Ø32		
Steel failure with rebar												
Characteristic resistance	$N_{Rk,s}$	[kN]	$A_s^{3)} \cdot f_{uk}^{4)}$									
Partial safety factor <sup>1)</sup>	$\gamma_{Ms}$	[-]	1.40									
<b>Combined pull-out and concrete cone failure in cracked concrete C20/25 for a working life of 50 years</b>												
Temperature range I: 24°C/40°C	$\tau_{Rk,cr,50}$	[N.mm <sup>-2</sup> ]	8	9	10	10	8.5	7.5	6	3.5		
Temperature range II: 50°C/80°C	$\tau_{Rk,cr,50}$	[N.mm <sup>-2</sup> ]	8	9	10	10	8.5	7.5	6	3.5		
Temperature range III: 80°C/120°C	$\tau_{Rk,cr,50}$	[N.mm <sup>-2</sup> ]	4.5	5	5	5	4.5	4	3	2		
Increasing factor	$\psi_c$	C30/37	1.04									
		C40/50	1.07									
		C50/60	1.09									
Sustained load factor	$\psi_{sus}^0$	24°C/40°C	0.72									
		50°C/80°C	0.72									
		80°C/120°C	0.61									
<b>Combined pull-out and concrete cone failure in non-cracked concrete C20/25 for a working life of 100 years</b>												
Temperature range I: 24°C / 40°C	$\tau_{Rk,cr,100}$	[N.mm <sup>-2</sup> ]	7.5	9	10	10	8.5	7.5	6	3.5		
Temperature range II: 50°C / 80°C	$\tau_{Rk,cr,100}$	[N.mm <sup>-2</sup> ]	7.5	9	10	10	8.5	7.5	6	3.5		
Increasing factor	$\psi_c$	C30/37	1.04									
		C40/50	1.07									
		C50/60	1.09									
<b>Concrete cone failure in cracked concrete</b>												
Factor for raked concrete	$k_{cr,N}$	[-]	7.7									
Edge distance	$c_{cr,N}$	[mm]	$1.5 \cdot h_{ef}$									
Spacing	$s_{cr,N}$	[mm]	$3.0 \cdot h_{ef}$									
<b>Splitting failure</b>												
Edge distance	$c_{cr,sp}$ for $h_{min}$	[mm]	$2.0 \cdot h_{ef}$					$1.5 \cdot h_{ef}$				
	$c_{cr,sp}$ for $h_{min} < h^{2)} < 2 \cdot h_{ef}$ ( $c_{cr,sp}$ from linear interpolation)											
	$c_{cr,sp}$ for $h^{2)} \geq 2 \cdot h_{ef}$		$c_{cr,N}$									
Spacing	$s_{cr,sp}$	[mm]	$2.0 \cdot c_{cr,sp}$									
<b>Installation safety factor for combined pull-out, concrete cone and splitting failure</b>												
Installation safety factors for use category I1 <sup>1)</sup>	standard cleaning	$\gamma_{inst}$	[-]	1.0								
	special cleaning			1.2	1.0					1.2		
Installation safety factors for use category I2 <sup>1)</sup>	standard cleaning			1.2								
	special cleaning			1.2	1.0					1.2		

<sup>1)</sup> In the absence of other national regulation.

<sup>2)</sup> h – concrete member thickness.

<sup>3)</sup> Stressed cross section of the steel.

<sup>4)</sup> Acc. to EN 1992-1-1.

SEL-V400+

Performance  
Characteristic resistance under tension loads for rebar  
in cracked concrete

Annex C8

## ANNEX C : Performance

**Table C7: Characteristic resistance under shear loads for threaded rod – steel failure without lever arm**

Size			M8	M10	M12	M16	M20	M24	M30
<b>Steel failure with threaded rod grade 5.8</b>									
Characteristic resistance	$V_{RK,s}$	[kN]	9	14	21	39	61	88	140
Factor considering ductility	$k_7$	[-]	0,8						
Partial safety factor <sup>1)</sup>	$\gamma_{Ms}$	[-]	1,25						
<b>Steel failure with threaded rod grade 8.8</b>									
Characteristic resistance	$V_{RK,s}$	[kN]	15	23	34	63	98	141	224
Factor considering ductility	$k_7$	[-]	0.8						
Partial safety factor <sup>1)</sup>	$\gamma_{Ms}$	[-]	1.25						
<b>Steel failure with threaded rod grade 10.9</b>									
Characteristic resistance	$V_{RK,s}$	[kN]	18	29	42	78	122	176	280
Factor considering ductility	$k_7$	[-]	0.8						
Partial safety factor <sup>1)</sup>	$\gamma_{Ms}$	[-]	1.50						
<b>Steel failure with threaded rod grade 12.9</b>									
Characteristic resistance	$V_{RK,s}$	[kN]	22	35	51	94	147	212	336
Factor considering ductility	$k_7$	[-]	0.8						
Partial safety factor <sup>1)</sup>	$\gamma_{Ms}$	[-]	1.50						
<b>Steel failure with stainless steel threaded rod A4-70</b>									
Characteristic resistance	$V_{RK,s}$	[kN]	13	20	29	55	86	124	196
Factor considering ductility	$k_7$	[-]	0.8						
Partial safety factor <sup>1)</sup>	$\gamma_{Ms}$	[-]	1.56						
<b>Steel failure with stainless steel threaded rod A4-80</b>									
Characteristic resistance	$V_{RK,s}$	[kN]	15	23	34	63	98	141	224
Factor considering ductility	$k_7$	[-]	0.8						
Partial safety factor <sup>1)</sup>	$\gamma_{Ms}$	[-]	1.33						
<b>Steel failure with high corrosion stainless steel grade 70</b>									
Characteristic resistance	$V_{RK,s}$	[kN]	13	20	29	55	86	124	196
Factor considering ductility	$k_7$	[-]	0.8						
Partial safety factor <sup>1)</sup>	$\gamma_{Ms}$	[-]	1.56						
<b>Steel failure with ultra-high strength steel threaded rod grade 14.8</b>									
Characteristic resistance	$V_{RK,s}$	[kN]	25	40	59	109	171	247	392
Factor considering ductility	$k_7$		0.8						
Partial safety factor <sup>1)</sup>	$\gamma_{Ms}$	[-]	1.50						
<b>Steel failure with ultra-high strength steel threaded rod grade 15.8</b>									
Characteristic resistance	$V_{RK,s}$	[kN]	27	43	63	117	183	264	420
Factor considering ductility	$k_7$	[-]	0.8						
Partial safety factor <sup>1)</sup>	$\gamma_{Ms}$	[-]	1.50						
<b>Steel failure with ultra-high strength steel threaded rod grade 16.8</b>									
Characteristic resistance	$V_{RK,s}$	[kN]	29	46	67	125	196	282	448
Factor considering ductility	$k_7$	[-]	0.8						
Partial safety factor <sup>1)</sup>	$\gamma_{Ms}$	[-]	1.50						

<sup>1)</sup> In the absence of other national regulation.

SEL-V400+

Performance  
Characteristic resistance under shear loads for threaded rod  
in cracked and uncracked concrete

Annex C9

### ANNEX C : Performance

**Table C8: Characteristic resistance under shear loads for threaded rod – steel failure with lever arm**

Size			M8	M10	M12	M16	M20	M24	M30
<b>Steel failure with threaded rod grade 5.8</b>									
Characteristic resistance	$M_{Rk,s}^0$	[Nm]	19	37	65	166	324	561	1124
Partial safety factor <sup>1)</sup>	$\gamma_{Ms}$	[-]	1.25						
<b>Steel failure with threaded rod grade 8.8</b>									
Characteristic resistance	$M_{Rk,s}^0$	[Nm]	30	60	105	266	519	898	1799
Partial safety factor <sup>1)</sup>	$\gamma_{Ms}$	[-]	1.25						
<b>Steel failure with threaded rod grade 10.9</b>									
Characteristic resistance	$M_{Rk,s}^0$	[Nm]	37	75	131	333	649	1123	2249
Partial safety factor <sup>1)</sup>	$\gamma_{Ms}$	[-]	1.50						
<b>Steel failure with threaded rod grade 12.9</b>									
Characteristic resistance	$M_{Rk,s}^0$	[Nm]	45	90	157	400	779	1347	2698
Partial safety factor <sup>1)</sup>	$\gamma_{Ms}$	[-]	1.50						
<b>Steel failure with stainless steel threaded rod A4-70</b>									
Characteristic resistance	$M_{Rk,s}^0$	[Nm]	26	52	92	233	454	786	1574
Partial safety factor <sup>1)</sup>	$\gamma_{Ms}$	[-]	1.56						
<b>Steel failure with stainless steel threaded rod A4-80</b>									
Characteristic resistance	$M_{Rk,s}^0$	[Nm]	30	60	105	266	519	898	1799
Partial safety factor <sup>1)</sup>	$\gamma_{Ms}$	[-]	1.33						
<b>Steel failure with high corrosion resistant steel grade 70</b>									
Characteristic resistance	$M_{Rk,s}^0$	[Nm]	26	52	92	233	454	786	1574
Partial safety factor <sup>1)</sup>	$\gamma_{Ms}$	[-]	1.56						
<b>Steel failure with ultra-high strength steel threaded rod grade 14.8</b>									
Characteristic resistance	$M_{Rk,s}^0$	[Nm]	52	104	183	466	908	1571	3148
Partial safety factor <sup>1)</sup>	$\gamma_{Ms}$	[-]	1.50						
<b>Steel failure with ultra-high strength steel threaded rod grade 15.8</b>									
Characteristic resistance	$M_{Rk,s}^0$	[Nm]	56	112	196	499	973	1683	3373
Partial safety factor <sup>1)</sup>	$\gamma_{Ms}$	[-]	1.50						
<b>Steel failure with ultra-high strength steel threaded rod grade 16.8</b>									
Characteristic resistance	$M_{Rk,s}^0$	[Nm]	59	119	209	532	1038	1796	3598
Partial safety factor <sup>1)</sup>	$\gamma_{Ms}$	[-]	1.50						

<sup>1)</sup> In the absence of other national regulation.

**Table C9: Characteristic resistance under shear loads – pry out and concrete edge failure for threaded rod**

Size			M8	M10	M12	M16	M20	M24	M30	
<b>Pry out failure</b>										
Pry out factor	$k_8$	[-]	2							
<b>Concrete edge failure</b>										
Outside diameter of anchor	$d_{nom}$	[mm]	8	10	12	16	20	24	30	
Effective length of anchor under shear loading	$l_f$	[mm]	$l_f = h_{ef}$ and $\leq 12 d_{nom}$						$l_f = h_{ef}$ and $\leq \max(8 \cdot d_{nom}; 300 \text{ mm})$	

SEL-V400+

Performance  
Characteristic resistance under shear loads for threaded rod in cracked and uncracked concrete

Annex C10

### ANNEX C : Performance

**Table C10 : Characteristic resistance under shear loads for rod with inner thread – steel failure without lever arm**

Size	M6/Ø10	M8/Ø12	M10/Ø16	M12/Ø16	M16/Ø24	
<b>Steel failure with rod with inner thread grade 5.8</b>						
Characteristic resistance	$V_{Rk,s}$ [kN]	5.0	9.2	14.5	21.1	39.3
Factor considering ductility	$k_7$ [-]	0.8				
Partial safety factor <sup>1)</sup>	$\gamma_{Ms}$ [-]	1.25				
<b>Steel failure with rod with inner thread grade 8.8</b>						
Characteristic resistance	$V_{Rk,s}$ [kN]	8.0	14.6	23.2	33.7	62.8
Factor considering ductility	$k_7$ [-]	0.8				
Partial safety factor <sup>1)</sup>	$\gamma_{Ms}$ [-]	1.25				
<b>Steel failure with stainless steel for rod with inner thread A4-70</b>						
Characteristic resistance	$V_{Rk,s}$ [kN]	7.0	12.8	20.3	29.5	55.0
Factor considering ductility	$k_7$ [-]	0.8				
Partial safety factor <sup>1)</sup>	$\gamma_{Ms}$ [-]	1.56				
<b>Steel failure with stainless steel for rod with inner thread A4-80</b>						
Characteristic resistance	$V_{Rk,s}$ [kN]	8.0	14.6	23.2	33.7	62.8
Factor considering ductility	$k_7$ [-]	0.8				
Partial safety factor <sup>1)</sup>	$\gamma_{Ms}$ [-]	1.33				
<b>Steel failure with high corrosion stainless steel grade 70</b>						
Characteristic resistance	$V_{Rk,s}$ [kN]	7.0	12.8	20.3	29.5	55.0
Factor considering ductility	$k_7$ [-]	0.8				
Partial safety factor <sup>1)</sup>	$\gamma_{Ms}$ [-]	1.56				

<sup>1)</sup> In the absence of other national regulation.

**Table C11 : Characteristic resistance under shear loads for rod with inner thread - steel failure with lever arm**

Size	M6/Ø10	M8/Ø12	M10/Ø16	M12/Ø16	M16/Ø24	
<b>Steel failure with rod with inner thread grade 5.8</b>						
Characteristic resistance	$M^0_{Rk,s}$ [Nm]	7.6	18.7	37.4	65.5	166.5
Partial safety factor <sup>1)</sup>	$\gamma_{Ms}$ [-]	1.25				
<b>Steel failure with rod with inner thread grade 8.8</b>						
Characteristic resistance	$M^0_{Rk,s}$ [Nm]	12.2	30.0	59.8	104.8	266.4
Partial safety factor <sup>1)</sup>	$\gamma_{Ms}$ [-]	1.25				
<b>Steel failure with stainless steel for rod with inner thread A4-70</b>						
Characteristic resistance	$M^0_{Rk,s}$ [Nm]	10.7	26.2	52.3	91.7	233.1
Partial safety factor <sup>1)</sup>	$\gamma_{Ms}$ [-]	1.56				
<b>Steel failure with stainless steel for rod with inner thread A4-80</b>						
Characteristic resistance	$M^0_{Rk,s}$ [Nm]	12.2	30.0	59.8	104.8	266.4
Partial safety factor <sup>1)</sup>	$\gamma_{Ms}$ [-]	1.33				
<b>Steel failure with high corrosion resistant steel grade 70</b>						
Characteristic resistance	$M^0_{Rk,s}$ [Nm]	10.7	26.2	52.3	91.7	233.1
Partial safety factor <sup>1)</sup>	$\gamma_{Ms}$ [-]	1.56				

<sup>1)</sup> In the absence of other national regulation.

**Table C12: Characteristic resistance under shear loads – pry out and concrete edge failure for rod with inner thread**

Size	M6/Ø10	M8/Ø12	M10/Ø16	M12/Ø16	M16/Ø24	
<b>Pry out failure</b>						
Factor	$k_8$ [-]	2				
<b>Concrete edge failure</b>						
Outside diameter of anchor	$d_{nom}$ [mm]	10	12	16	16	24
Effective length of anchor under shear loading	$l_f$ [mm]	$l_f = h_{ef}$ and $\leq 12 d_{nom}$				

SEL-V400+

Performance  
Characteristic resistance under shear loads for threaded rod in cracked and uncracked concrete

Annex C11

## ANNEX C : Performance

**Table C13 : Characteristic resistance under shear loads for rebar – steel failure without lever arm**

Size			Ø8	Ø10	Ø12	Ø14	Ø16	Ø20	Ø25	Ø32
<b>Steel failure with rebar</b>										
Characteristic resistance	$V_{Rk,s}$	[kN]	$0.5 \cdot A_s^{2) \cdot f_{uk}^{3)}$							
Factor considering ductility	$k_7$	[-]	0.8							
Partial safety factor <sup>1)</sup>	$\gamma_{Ms}$	[-]	1.5							

<sup>1)</sup> In the absence of other national regulation.

<sup>2)</sup> Stressed cross section of the steel element.

<sup>3)</sup> Acc. to EN 1992-1-1.

**Table C14 : Characteristic resistance under shear loads for rebar – steel failure with lever arm**

Size			Ø8	Ø10	Ø12	Ø14	Ø16	Ø20	Ø25	Ø32
<b>Steel failure with rebar</b>										
Characteristic resistance	$M_{Rk,s}^0$	[Nm]	$1.2 \cdot W_{el}^{2) \cdot f_{uk}^{3)}$							
Partial safety factor <sup>1)</sup>	$\gamma_{Ms}$	[-]	1.5							

<sup>1)</sup> In the absence of other national regulation.

<sup>2)</sup> Elastic section modulus calculated from the stressed cross section of steel element.

<sup>3)</sup> Acc. to EN 1992-1-1.

**Table C15 : Characteristic resistance under shear loads – pry out and concrete edge failure for rebar**

Size			Ø8	Ø10	Ø12	Ø14	Ø16	Ø20	Ø25	Ø32	
<b>Pry out failure</b>											
Factor	$k_8$	[-]	2								
<b>Concrete edge failure</b>											
Outside diameter of anchor	$d_{nom}$	[mm]	8	10	12	14	16	20	25	32	
Effective length of anchor under shear loading	$l_f$	[mm]	$l_f = h_{ef} \text{ and } \leq 12 d_{nom}$							$l_f = h_{ef}$ and $\leq \max(8 \cdot d_{nom}; 300 \text{ mm})$	

SEL-V400+

Performance  
Characteristic resistance under shear loads  
in cracked and uncracked concrete

Annex C12

## ANNEX C : Performance

**Table C16 : Displacement under tension loads – threaded rod**

Size			M8	M10	M12	M16	M20	M24	M30
<b>Characteristic displacement in uncracked concrete C20/25 to C50/60 under tension loads</b>									
Displacement <sup>1)</sup>	$\delta_{N0}$	[mm]	0.3	0.4	0.4	0.5	0.5	0.6	0.7
	$\delta_{N\infty}$	[mm]	0.6	0.6	0.6	0.6	0.6	0.6	0.6
<b>Characteristic displacement in cracked concrete C20/25 to C50/60 under tension loads</b>									
Displacement <sup>1)</sup>	$\delta_{N0}$	[mm]	0.3	0.4	0.4	0.5	0.5	0.6	0.6
	$\delta_{N\infty}$	[mm]	2	2	2	2	2	2	2
<sup>1)</sup> These values are suitable for each temperature range and categories specified in Annex B1. Calculation of the displacement: $\delta_{N0} = \delta_{N0\text{-factor}} \cdot N$ ; $\delta_N = \delta_{N\infty\text{-factor}} \cdot N$ ; (N – applied tension load)									

**Table C17 : Displacement under shear loads – threaded rod**

Size			M8	M10	M12	M16	M20	M24	M30
<b>Characteristic displacement in cracked and uncracked concrete C20/25 to C50/60 under shear loads</b>									
Displacement <sup>1)</sup>	$\delta_{V0}$	[mm]	2.5	2.5	2.5	2.5	2.5	2.5	2.5
	$\delta_{V\infty}$	[mm]	3.7	3.7	3.7	3.7	3.7	3.7	3.7
<sup>1)</sup> These values are suitable for each temperature range and categories specified in Annex B1. Calculation of the displacement: $\delta_{V0} = \delta_{V0\text{-factor}} \cdot V$ ; $\delta_V = \delta_{V\infty\text{-factor}} \cdot V$ ; (V – applied shear load)									

SEL-V400+

Performance  
Displacement under service loads: tension and shear loads – threaded rod

Annex C13



## ANNEX C : Performance

**Table C18 : Displacement under tension loads – rod with inner thread**

Size		M6/ Ø10	M8/ Ø12	M10/Ø 16	M12/Ø 16	M16/Ø 24	
<b>Characteristic displacement in uncracked concrete C20/25 to C50/60 under tension loads</b>							
Displacement <sup>1)</sup>	$\delta_{N0}$	[mm]	0.2	0.3	0.3	0.4	0.4
	$\delta_{N\infty}$	[mm]	0.6	0.6	0.6	0.6	0.6
<b>Characteristic displacement in cracked concrete C20/25 to C50/60 under tension loads</b>							
Displacement <sup>1)</sup>	$\delta_{N0}$	[mm]	0.3	0.4	0.4	0.5	0.3
	$\delta_{N\infty}$	[mm]	2	2	2	2	2
<sup>1)</sup> These values are suitable for each temperature range and categories specified in Annex B1. Calculation of the displacement: $\delta_{N0} = \delta_{N0\text{-factor}} \cdot N$ ; $\delta_N = \delta_{N\infty\text{-factor}} \cdot N$ ; (N – applied tension load)							

**Table C19 : Displacement under shear loads – rod with inner thread**

Size		M6/ Ø10	M8/ Ø12	M10/ Ø16	M12/ Ø16	M16/ Ø24	
<b>Characteristic displacement in cracked and uncracked concrete C20/25 to C50/60 under shear loads</b>							
Displacement <sup>1)</sup>	$\delta_{V0}$	[mm]	2.5	2.5	2.5	2.5	2.5
	$\delta_{V\infty}$	[mm]	3.7	3.7	3.7	3.7	3.7
<sup>1)</sup> These values are suitable for each temperature range and categories specified in Annex B1. Calculation of the displacement: $\delta_{V0} = \delta_{V0\text{-factor}} \cdot V$ ; $\delta_V = \delta_{V\infty\text{-factor}} \cdot V$ ; (V – applied shear load)							

SEL-V400+

Performance  
 Displacement under service loads: tension and shear loads – rod with inner thread

Annex C14

## ANNEX C : Performance

**Table C20 : Displacement under tension loads – rebar**

Size			Ø8	Ø10	Ø12	Ø14	Ø16	Ø20	Ø25	Ø32
<b>Characteristic displacement in uncracked concrete C20/25 to C50/60 under tension loads</b>										
Displacement <sup>1)</sup>	$\delta_{N0}$	[mm]	0.3	0.3	0.4	0.4	0.5	0.6	0.6	0.8
	$\delta_{N\infty}$	[mm]	0.6	0.6	0.6	0.6	0.6	0.6	0.6	0.6
<b>Characteristic displacement in cracked concrete C20/25 to C50/60 under tension loads</b>										
Displacement <sup>1)</sup>	$\delta_{N0}$	[mm]	0.3	0.3	0.3	0.4	0.5	0.6	0.6	0.7
	$\delta_{N\infty}$	[mm]	2	2	2	2	2	2	2	2
<sup>1)</sup> These values are suitable for each temperature range and categories specified in Annex B1. Calculation of the displacement: $\delta_{N0} = \delta_{N0\text{-factor}} \cdot N$ ; $\delta_N = \delta_{N\infty\text{-factor}} \cdot N$ ; (N – applied tension load)										

**Table C21 : Displacement under shear loads – rebar**

Size			Ø8	Ø10	Ø12	Ø14	Ø16	Ø20	Ø25	Ø32
<b>Characteristic displacement in cracked and uncracked concrete C20/25 to C50/60 under shear loads</b>										
Displacement <sup>1)</sup>	$\delta_{V0}$	[mm]	2.5	2.5	2.5	2.5	2.5	2.5	2.5	2.5
	$\delta_{V\infty}$	[mm]	3.7	3.7	3.7	3.7	3.7	3.7	3.7	3.7
<sup>1)</sup> These values are suitable for each temperature range and categories specified in Annex B1. Calculation of the displacement: $\delta_{V0} = \delta_{V0\text{-factor}} \cdot V$ ; $\delta_V = \delta_{V\infty\text{-factor}} \cdot V$ ; (V – applied shear load)										

SEL-V400+

Performance  
 Displacement under service loads: tension and shear loads – rebar

Annex C15

### ANNEX C : Performance

**Table C22 : Characteristic resistance under tension load for threaded rod for seismic performance category C1**

Size	M8	M10	M12	M16	M20	M24	M30		
<b>Steel failure</b>									
Steel failure with threaded rod grade 5.8									
Characteristic resistance	$N_{Rk,s.seis}$	[kN]	18	29	42	78	122	176	280
Partial safety factor <sup>1)</sup>	$\gamma_{Ms.seis}$	[-]	1.50						
Steel failure with threaded rod grade 8.8									
Characteristic resistance	$N_{Rk,s.seis}$	[kN]	29	46	67	125	196	282	448
Partial safety factor <sup>1)</sup>	$\gamma_{Ms.seis}$	[-]	1.50						
Steel failure with stainless steel threaded rod A4-70									
Characteristic resistance	$N_{Rk,s.seis}$	[kN]	25	40	59	109	171	247	392
Partial safety factor <sup>1)</sup>	$\gamma_{Ms.seis}$	[-]	1.87						
Steel failure with stainless steel threaded rod A4-80									
Characteristic resistance	$N_{Rk,s.seis}$	[kN]	29	46	67	125	196	282	448
Partial safety factor <sup>1)</sup>	$\gamma_{Ms.seis}$	[-]	1.60						
Steel failure with high corrosion resistant steel grade 70									
Characteristic resistance	$N_{Rk,s.seis}$	[kN]	25	40	59	109	171	247	392
Partial safety factor <sup>1)</sup>	$\gamma_{Ms.seis}$	[-]	1.87						
<b>Combined pull-out and concrete cone failure in uncracked concrete C20/25 for a working life of 50 years</b>									
Characteristic bond resistance									
Temperature range I: 24°C / 40°C	$\tau_{Rk,ucr.seis.50}$	[N.mm <sup>-2</sup> ]	8.0	10.0	10.0	9.5	7.5	7.0	4.0
Temperature range II: 50°C / 80°C	$\tau_{Rk,ucr.seis.50}$	[N.mm <sup>-2</sup> ]	8.0	10.0	10.0	9.5	7.5	7.0	4.0
Temperature range II: 80°C/120°C	$\tau_{Rk,ucr.seis.50}$	[N.mm <sup>-2</sup> ]	4.5	5.0	6.0	5.0	4.0	4.0	2.0
<b>Combined pull-out and concrete cone failure in uncracked concrete C20/25 for a working life of 100 years</b>									
Characteristic bond resistance									
Temperature range I: 24°C / 40°C	$\tau_{Rk,ucr.seis.100}$	[N.mm <sup>-2</sup> ]	8.0	9.0	10.0	9.5	7.5	7.0	4.0
Temperature range II: 50°C / 80°C	$\tau_{Rk,ucr.seis.100}$	[N.mm <sup>-2</sup> ]	8.0	9.0	10.0	9.5	7.5	7.0	4.0

**Table C23: Characteristic resistance under tension load for rebar for seismic performance category C1**

Size	Ø8	Ø10	Ø12	Ø14	Ø16	Ø20	Ø25	Ø32		
<b>Steel failure with rebar</b>										
Characteristic resistance	$N_{Rk,s.seis}$	[kN]	$A_s^{2)} \cdot f_{uk}^{3)}$							
Partial safety factor <sup>1)</sup>	$\gamma_{Ms.seis}$	[-]	1.40							
<b>Combined pull-out and concrete cone failure in uncracked concrete C20/25 for a working life of 50 years</b>										
Characteristic bond resistance										
Temperature range I: 24°C / 40°C	$\tau_{Rk,ucr.seis.50}$	[N.mm <sup>-2</sup> ]	7.0	8.5	10.0	10.0	8.5	7.5	6.0	3.5
Temperature range II: 50°C / 80°C	$\tau_{Rk,ucr.seis.50}$	[N.mm <sup>-2</sup> ]	7.0	8.5	10.0	10.0	8.5	7.5	6.0	3.5
Temperature range II: 80°C / 120°C	$\tau_{Rk,ucr.seis.50}$	[N.mm <sup>-2</sup> ]	4.0	4.5	5.0	5.0	4.5	4.0	3.0	1.5
<b>Combined pull-out and concrete cone failure in uncracked concrete C20/25 for a working life of 100 years</b>										
Characteristic bond resistance										
Temperature range I: 24°C / 40°C	$\tau_{Rk,ucr.seis.100}$	[N.mm <sup>-2</sup> ]	6.0	8.5	10.0	10.0	8.5	7.5	6.0	3.5
Temperature range II: 50°C / 80°C	$\tau_{Rk,ucr.seis.100}$	[N.mm <sup>-2</sup> ]	6.0	8.5	10.0	10.0	8.5	7.5	6.0	3.5

<sup>1)</sup> In the absence of other national regulation.

<sup>2)</sup> Stressed cross section of the steel element.

<sup>3)</sup> Acc. to EN 1992-1-1.

SEL-V400+

Performance  
Characteristic resistance under tension loads for threaded and rebar  
for seismic action category C1

Annex C16

## ANNEX C : Performance

**Table C24 : Characteristic resistance under shear loads for threaded rod for seismic performance category C1 - steel failure without lever arm**

Size			M8	M10	M12	M16	M20	M24	M30
<b>Steel failure with threaded rod grade 5.8</b>									
Characteristic resistance	$V_{Rk,s,seis}$	[kN]	6.3	10.1	14.7	27.3	42.7	61.6	98.0
Partial safety factor <sup>1)</sup>	$\gamma_{Ms,seis}$	[-]	1.25						
<b>Steel failure with threaded rod grade 8.8</b>									
Characteristic resistance	$V_{Rk,s,seis}$	[kN]	10.2	16.1	23.5	44.1	68.6	98.7	156.8
Partial safety factor <sup>1)</sup>	$\gamma_{Ms,seis}$	[-]	1.25						
<b>Steel failure with stainless steel threaded rod A4-70</b>									
Characteristic resistance	$V_{Rk,seis}$	[kN]	9.1	14.4	20.7	38.5	59.9	86.5	137.4
Partial safety factor <sup>1)</sup>	$\gamma_{Ms,seis}$	[-]	1.56						
<b>Steel failure with stainless steel threaded rod A4-80</b>									
Characteristic resistance	$V_{Rk,seis}$	[kN]	10.2	16.1	23.5	44.1	68.6	98.7	157.2
Partial safety factor <sup>1)</sup>	$\gamma_{Ms,seis}$	[-]	1.33						
<b>Steel failure with high corrosion stainless steel grade 70</b>									
Characteristic resistance	$V_{Rk,seis}$	[kN]	9.1	14.4	20.7	38.5	59.9	86.5	137.4
Partial safety factor <sup>1)</sup>	$\gamma_{Ms,seis}$	[-]	1.56						

<sup>1)</sup> In the absence of other national regulation.

**Table C25: Characteristic resistance under shear loads for rebar for seismic performance category C1 – steel failure without lever arm**

Size			Ø8	Ø10	Ø12	Ø14	Ø16	Ø20	Ø25	Ø32
<b>Steel failure with rebar</b>										
Characteristic resistance	$V_{Rk,s,seis}$	[kN]	$0.35 \cdot A_s^{2)} \cdot f_{uk}^{3)}$							
Partial safety factor <sup>1)</sup>	$\gamma_{Ms,seis}$	[-]	1.5							

<sup>1)</sup> In the absence of other national regulation.

<sup>2)</sup> Stressed cross section of the steel element.

<sup>3)</sup> Acc. to EN 1992-1-1.

SEL-V400+

Performance  
Characteristic resistance under shear loads for threaded and rebar  
for seismic action category C1

Annex C17

## ANNEX C : Performance

**Table C26 : Displacement under tension loads – threaded rod for seismic performance category C1**

Size			M8	M10	M12	M16	M20	M24	M30
Displacement	$\delta_{N,seis}$	[mm]	3.0	3.1	3.5	4.0	5.0	6.0	6.6

**Table C27: Displacement under shear loads – threaded rod for seismic performance category C1**

Size			M8	M10	M12	M16	M20	M24	M30
Displacement	$\delta_{V,seis}$	[mm]	3.5	4.0	4.6	5.0	5.8	6.5	7.0

**Table C28: Displacement under tension loads – rebar for seismic performance category C1**

Size			Ø8	Ø10	Ø12	Ø14	Ø16	Ø20	Ø25	Ø32
Displacement	$\delta_{N,seis}$	[mm]	3.0	3.1	3.5	4.0	4.0	5.0	6.0	6.4

**Table C29: Displacement under shear loads – rebar for seismic performance category C1**

Size			Ø8	Ø10	Ø12	Ø14	Ø16	Ø20	Ø25	Ø32
Displacement	$\delta_{V,seis}$	[mm]	3.5	4.0	4.6	5.0	5.0	5.8	6.5	7.2

SEL-V400+

Performance  
Displacement under service loads: tension and shear loads  
for seismic action category C1

Annex C18

# SEL V400+ HYBRID RESIN

Technical Assessment UKTA-0836-22/6236

Issued on 29/07/2022



**British Board of Agrément**

1<sup>st</sup> Floor Building 3  
Hatters Lane  
Croxley Park  
Watford  
WD18 8YG